

PRESMA[®]

Precision Targeting Solutions

2017 Catalog / Presmainc.com

Scopes / Handguards / Binoculars / Scope Rings
Grips / BiPods / Laser Sights / Hunting Accessories

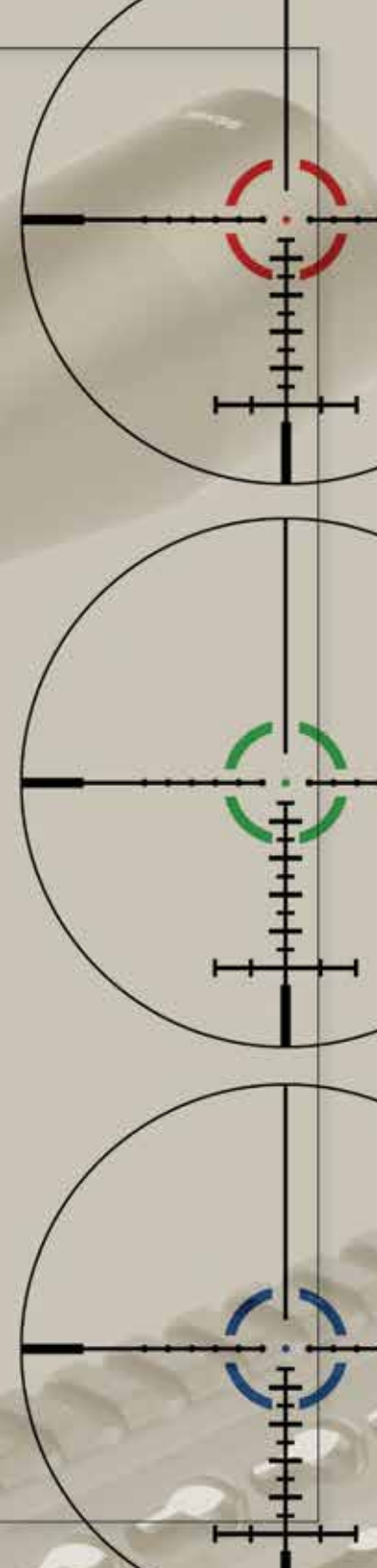

Presma® Eagle Series Precision Rifle Scopes

The Presma® Eagle Riflescope is a versatile, variable powered riflescope equipped with tri-color electronic illuminated reticles. The easy to access and clickable color/brightness buttons are designated on a 45 degree of surface on the rear of scope.

Selectable 11 brightness adjustment control lets the user adapt to different terrains and temperatures. Automated shut down power to conserve battery's life and memorize the last reticle color and brightness position when the power is on.

Mounted level bubble on the rear of tube provides tool of stability level. And comes with a bonus sunshade to block unwanted lights allowing user to see target with more clear result.

Presma Eagle series riflescopes are CNC machined from one piece of 6061-T6 aluminum and hard anodized against corrosion with a black matte finish; Sealed O-ring and Argon filled for waterproof, fogproof and shock proof performance.

This compact design makes easy maneuvering possible in real hunting and shooting activities.

Featuring a high quality fully multi-coated lens, Presma Eagle series Riflescope forms clear, bright and sharp sight image edge to edge.



Product	Mag X	Length	Weight	1 Click	Obj. Dia.	Reticle Style	Exit Pupil	FOV (Ft / 100Yds)	Tube Dia.	W/E Adj. Value	Eye Relief	Parallax (Yds)	Battery	Diopter range
PREA011	4-16X	12.9 inch	18.9 oz	1/4 MOA	40 mm	RXR	10/2.5 mm	6.5 / 26.4	1 Inch	±30 MOA	3/3.3 inch	10-Infi	CR2032	±2
PREA021	3-12X	10.8 inch	17.3 oz	1/4 MOA	44 mm	RXR	12/3.6 mm	9.0 / 38.9	1 Inch	±30 MOA	3/3.3 inch	100	CR2032	±2
PREA031	6-24X	13.8 inch	22.6 oz	1/8 MOA	50 mm	RXR	8/2.1 mm	4.5 / 18.9	1 Inch	±24 MOA	3/3.3 inch	10-Infi	CR2032	±2
PREA041	4-16X	12.9 inch	22.2 oz	1/4 MOA	50 mm	RXR	10/3.1 mm	6.5 / 26.4	1 Inch	±30 MOA	3/3.3 inch	10-Infi	CR2032	±2

Patent Pending

Presma® Eagle Series Precision Rifle Scopes

Presma® Eagle Series 6-24X50 Precision Scope AO, RGB RXR Reticle

PREA031

- One piece scope ring mount with quick release bottom.
- 11 levels of Red, Green, Blue illuminated reticle.
- Illumination adjustment memorizes last level of selection.
- RXR estimate reticle.
- Integrated level bubble.
- Superior quality precision lens elements.
- Aluminum 6061-T6 tube with scratch resistant hard-coat anodized black matte finish.
- Built on strong cardan joint platform to fulfill the most demanding outdoor requirement.
- Fully multicoated lenses & ultra wide band coating with advantage solution for maximum light transmission.
- Completely sealed and Argon filled.
- 100% shockproof, Fog-proofed; water-proofed.
- Flip open lens covers.
- 3" sunshade included.
- Lifetime limited warranty (Electrical components covered one year).



PRESMA

Patent Pending

Presma® Eagle Series Precision Rifle Scopes

Presma® Eagle Series 4-16X50 Precision Scope AO, RGB RXR Reticle

PREA041

- One piece scope ring mount with quick release bottom.
- 11 levels of Red, Green, Blue illuminated reticle.
- Illumination adjustment memorizes last level of selection.
- RXR estimate reticle.
- Integrated level bubble.
- Superior quality precision lens elements.
- Aluminum 6061-T6 tube with scratch resistant hard-coat anodized black matte finish.
- Built on strong cardan joint platform to fulfill the most demanding outdoor requirement.
- Fully multicoated lenses with advantage solution for maximum light transmission.
- Completely sealed and Argon filled.
- 100% shockproof, Fog-proofed; water-proofed.
- Flip open lens covers.
- 3" sunshade included.
- Lifetime limited warranty (Electrical components covered one year).

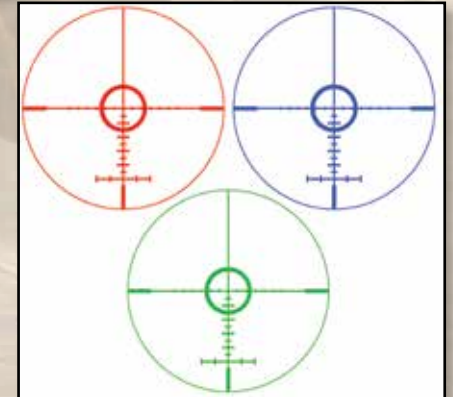

Patent Pending

Presma® Eagle Series Precision Rifle Scopes

Presma® Eagle Series 4-16X40 Precision Scope AO, RGB RXR Reticle

PREA011

- One piece scope ring mount with quick release bottom.
- 11 levels of Red, Green, Blue illuminated reticle.
- Illumination adjustment memorizes last level of selection.
- RXR estimate reticle.
- Integrated level bubble.
- Superior quality precision lens elements.
- Aluminum 6061-T6 tube with scratch resistant hard-coat anodized black matte finish.
- Built on strong cardan joint platform to fulfill the most demanding outdoor requirement.
- Fully multicoated lenses with advantage solution for maximum light transmission.
- Completely sealed and Argon filled.
- 100% shockproof, Fog-proofed; water-proofed.
- Flip open lens covers.
- 2.5" sunshade included.
- Lifetime limited warranty (Electrical components covered one year).

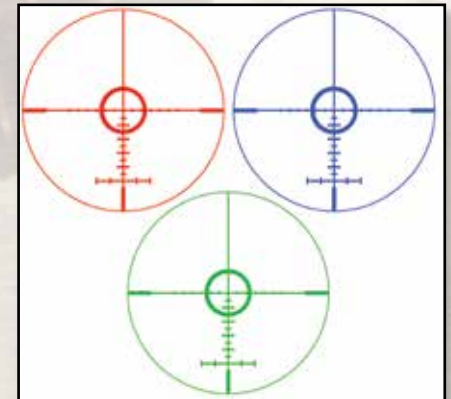

Patent Pending

Presma® Eagle Series Precision Rifle Scopes

Presma® Eagle Series 3-12X44 Precision Scope, RGB RXR Reticle

PREA021

- One piece scope ring mount with quick release bottom.
- 11 levels of Red, Green, Blue illuminated reticle.
- Illumination adjustment memorizes last level of selection.
- RXR estimate reticle.
- Integrated level bubble.
- Superior quality precision lens elements.
- Aluminum 6061-T6 tube with scratch resistant hard-coat anodized black matte finish.
- Built on strong cardan joint platform to fulfill the most demanding outdoor requirement.
- Fully multicoated lenses with advantage solution for maximum light transmission.
- Completely sealed and Argon filled.
- 100% shockproof, Fog-proofed; water-proofed.
- Flip open lens covers.
- 2.5" sunshade included.
- Lifetime limited warranty (Electrical components covered one year).



Patent Pending

Presma® Hawk Series Precision Rifle Scopes

Fully multicoated lenses with ultra wide band coating for crystal clear clarity and durability.

RGB RXR Glass Reticle with Side Parallax Adjustment, Level Bubble and Electronic button switch.

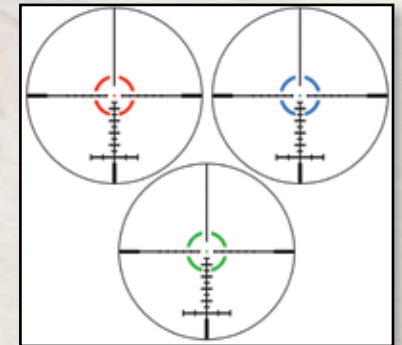

Product	Mag X	Length	Weight	1 Click	Obj. Dia.	Reticle Style	Exit Pupil	FOV (Ft / 100Yds)	Tube Dia.	W/E Adj. Value	Eye Relief	Parallax (Yds)	Battery	Diopter range
PRHA021	6-24X	13.8 inch	22.1 oz	1/8 MOA	50 mm	RXR	8/2.1 mm	4.5 / 18.9	1 Inch	±25 MOA	3/3.3 inch	15-Infi	CR2032	±2
PRHA031	2-10X	10.9 inch	18.2 oz	1/4 MOA	44 mm	RXR	12/4.4 mm	8.7 / 43.9	30 mm	±40 MOA	3/3.3 inch	100	CR2032	±2
PRHA041	3-15X	12.3 inch	22 oz	1/8 MOA	50 mm	RXR	12/3.3 mm	6.1 / 30.5	30 mm	±30 MOA	3/3.3 inch	20-Infi	CR2032	±2
PRHA051	4-20X	13.5 inch	21.9 oz	1/8 MOA	50 mm	RXR	10/2.5 mm	4.4 / 21.8	30 mm	±25 MOA	3/3.3 inch	30-Infi	CR2032	±2

Patent Pending

Presma® Hawk Series Precision Rifle Scopes

Presma® Hawk Series 6-24X50 Precision Scope, RGB RXR Glass Reticle

PRHA021

- Fully multicoated lens with ultra wide band coating
- Level bubble
- Electronic button switch
- Flip up lens covers
- 1" one piece tube
- 3" sunshade
- Glass reticle and side parallax adjustment
- Lifetime limited warranty (Electrical components covered one year).

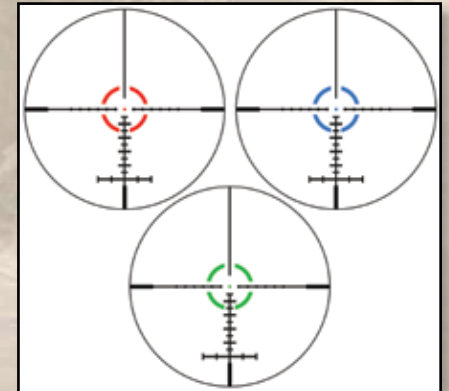

Patent Pending

Presma® Hawk Series Precision Rifle Scopes

Presma® Hawk Series 4-20X50 Precision Scope, RGB RXR Glass Reticle

PRHA051

- Fully multicoated lens with ultra wide band coating
- Level bubble
- Electronic button switch
- Flip up lens covers
- 1" one piece tube
- 3" sunshade
- Glass reticle and side parallax adjustment
- Lifetime limited warranty (Electrical components covered one year).

New

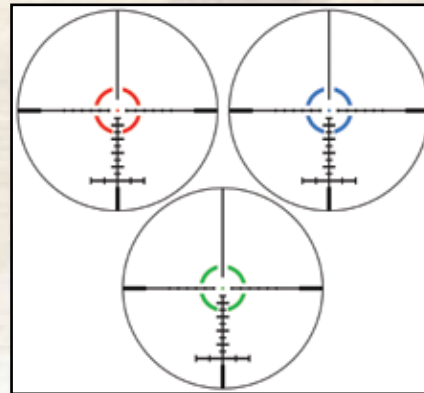

Patent Pending

Presma® Hawk Series Precision Rifle Scopes

Presma® Hawk Series 3-15X50 Precision Scope, RGB RXR Glass Reticle

PRHA041

- Fully multicoated lens with ultra wide band coating
- Level bubble
- Electronic button switch
- Flip up lens covers
- 1" one piece tube
- 3" sunshade
- Glass reticle and side parallax adjustment
- Lifetime limited warranty (Electrical components covered one year).

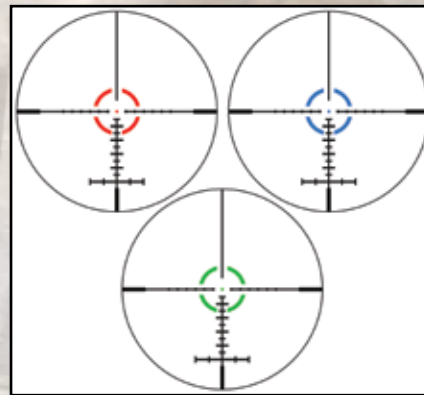

Patent Pending

Presma® Hawk Series Precision Rifle Scopes

Presma® Hawk Series 2-10X44 Precision Scope, RGB RXR Glass Reticle

PRHA031

- Fully multicoated lens with ultra wide band coating
- Level bubble
- Electronic button switch
- Flip up lens covers
- 1" one piece tube
- 2.5" sunshade
- Glass reticle
- Lifetime limited warranty (Electrical components covered one year).

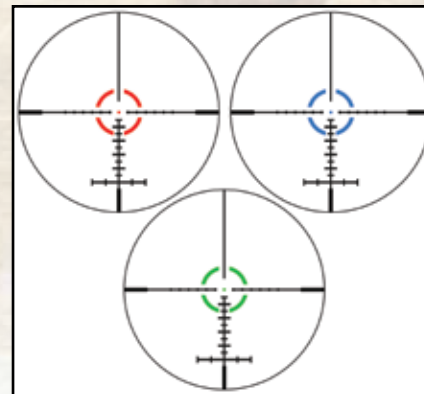

Patent Pending

Presma® Hawk 6 Series Precision Rifle Scopes

Optics that match with markets premium brands scope's performance...

Clear and Sharp Image formation with all round coverage edge to edge image clarity.



RXR glass reticle includes Quick Targeting Round X circle and range estimation

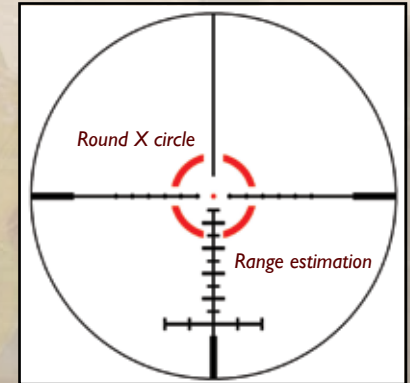

Red, Green, Blue tri-color illumination button on unique 45 degree tube surface so it won't interfere with ocular lens viewing . Easy to adjust and comes with last active color memory function.

Ocular Lens equipped with bubble level to help align scope mounting and aiming level. During the course of shooting, it confirms rifle is always in horizon level.



45 degree tube surface

Bubble Level

RGB Illumination Buttons

Piano keyboard shape engraved grooves on all turrets and wheels' circumference for easy adjusting, even when wearing a glove.



Piano keyboard shaped grooves

Pin Tumbler coil spring System design provides better shock absorbability and resistant. During shooting recoil, the reticle stays in place, making the Hawk 6 durable and keeps the aim accurate.



Pin tumbler coil spring system

Product	Mag X	Length	Weight	1 Click	Obj. Dia.	Reticle Style	Exit Pupil	FOV (Ft / 100Yds)	Tube Dia.	W/E Adj. Value	Eye Relief	Parallax (Yds)	Battery	Diopter range
PRHA6011	1-6X	10.6 inch	18.3 oz	1/4 MOA	28 mm	RXR	14/4.6 mm	17.3 / 103.3	35 mm	±80 MOA	4/5.3 inch	100	CR2032	±2
PRHA6021	2-12X	12 inch	20.8 oz	1/4 MOA	44 mm	RXR	12/3.6 mm	7.9 / 44.8	35 mm	±60 MOA	3.8/4 inch	100	CR2032	±2
PRHA6031	3-18X	13.6 inch	24 oz	1/8 MOA	50 mm	RXR	12/2.7 mm	5.8 / 32.6	35 mm	±40 MOA	4/5.3 inch	20-Infi	CR2032	±2
PRHA6041	4-24X	15 inch	26.8 oz	1/8 MOA	56 mm	RXR	10/2.3 mm	4.4 / 26.2	35 mm	±30 MOA	4/5.3 inch	25-Infi	CR2032	±2
PRHA6051	6-36X	15.6 inch	28.5 oz	1/10 MOA	56 mm	RXR	8/1.5 mm	2.8 / 16.8	35 mm	±20 MOA	3.9/4.2 inch	15-Infi	CR2032	±2

Patent Pending

Presma® Hawk 6 Series Precision Rifle Scopes

Presma® Hawk 6 Series 6-36X56 Precision Scope, RGB RXR Glass Reticle

PRHA6051

- Clear and Sharp Image formation. Edge to edge image clarity
- Emerald coated lens, fully multi-coated, for the most excellent light transmission
- Side wheel turret parallax adjustment with range from 15 yards to infinity
- One piece 35 mm tube body with Cardan joint design constructed in premium aircraft class aluminum, hard anodized and matte finish for durability
- Red, Green, Blue tri-color reticle illumination button on unique 45 degree tube surface with last active color memory function. Automated power off to conserve battery's life
- Ocular Lens equipped with bubble level to align mounting scope and aiming level with unique 45 degree tube surface design that won't interfere with ocular lens viewing.
- QTA (Quick Tactical Adjustment) system applied in windage and elevation adjustment
- Pin Tumbler coil spring System design provides better shock absorbability and resistance

- Each direction adjust to 20 MOA
- RXR reticle has two functions: Quick Targeting Round X circle and range estimation
- Shockproof, waterproof and fogproof; 100% Argon filled and sealed with O-Ring
- Piano keyboard shape engraved grooves on all turrets and wheels' circumference makes it easy to adjust even when wearing gloves
- 56mm Objective Lens for ample light transmission
- Lifetime limited warranty (Electrical components covered one year).

PRESMA



Patent Pending

Presma® Hawk 6 Series Precision Rifle Scopes

Presma® Hawk 6 Series 4-24X56 Precision Scope, RGB RXR Glass Reticle

PRHA6041

- Clear and Sharp Image formation. Edge to edge image clarity
- Emerald coated lens, fully multi-coated, for the most excellent light transmission
- Side wheel turret parallax adjustment with range from 25 yards to infinity
- One piece 35 mm tube body with Cardan joint design constructed in premium aircraft class aluminum, hard anodized and matte finish for durability
- Red, Green, Blue tri-color reticle illumination button on unique 45 degree tube surface with last active color memory function. Automated power off to conserve battery's life
- Ocular Lens equipped with bubble level to align mounting scope and aiming level with unique 45 degree tube surface design that won't interfere with ocular lens viewing.
- QTA (Quick Tactical Adjustment) system applied in windage and elevation adjustment
- Pin Tumbler coil spring System design provides better shock absorbability and resistance
- Each direction adjust to 30 MOA

- RXR reticle has two functions: Quick Targeting Round X circle and range estimation
- Shockproof, waterproof and fogproof; 100% Argon filled and sealed with O-Ring
- Piano keyboard shape engraved grooves on all turrets and wheels' circumference makes it easy to adjust even when wearing gloves
- 56mm Objective Lens for ample light transmission
- Lifetime limited warranty (Electrical components covered one year).



Patent Pending

Presma® Hawk 6 Series Precision Rifle Scopes

Presma® Hawk 6 Series 3-18X50 Precision Scope, RGB RXR Glass Reticle

PRHA6031

- Clear and Sharp Image formation. Edge to edge image clarity
- Emerald coated lens, fully multi-coated, for the most excellent light transmission
- Side wheel turret parallax adjustment with range from 20 yards to infinity
- One piece 35 mm tube body with Cardan joint design constructed in premium aircraft class aluminum, hard anodized and matte finish for durability
- Red, Green, Blue tri-color reticle illumination button on unique 45 degree tube surface with last active color memory function. Automated power off to conserve battery's life
- Ocular Lens equipped with bubble level to align mounting scope and aiming level with unique 45 degree tube surface design that won't interfere with ocular lens viewing.
- QTA (Quick Tactical Adjustment) system applied in windage and elevation adjustment
- Pin Tumbler coil spring System design provides better shock absorbability and resistance
- Each direction adjust to 40 MOA

- RXR reticle has two functions: Quick Targeting Round X circle and range estimation
- Shockproof, waterproof and fogproof; 100% Argon filled and sealed with O-Ring
- Piano keyboard shape engraved grooves on all turrets and wheels' circumference makes it easy to adjust even when wearing gloves
- 50mm Objective Lens for ample light transmission
- Lifetime limited warranty (Electrical components covered one year).

New

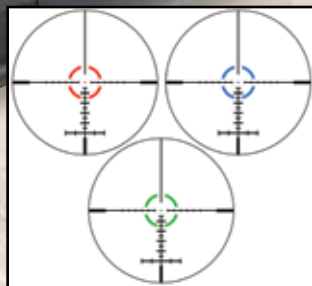

PRESMA

Patent Pending

Presma® Hawk 6 Series Precision Rifle Scopes

Presma® Hawk 6 Series 2-12X44 Precision Scope, RGB RXR Glass Reticle

PRHA6021

- Clear and Sharp Image formation. Edge to edge image clarity
- Emerald coated lens, fully multi-coated, for the most excellent light transmission
- One piece 35 mm tube body with Cardan joint design constructed in premium aircraft class aluminum, hard anodized and matte finish for durability
- Red, Green, Blue tri-color reticle illumination button on unique 45 degree tube surface with last active color memory function. Automated power off to conserve battery's life
- Ocular Lens equipped with bubble level to align mounting scope and aiming level with unique 45 degree tube surface design that won't interfere with ocular lens viewing.
- QTA (Quick Tactical Adjustment) system applied in windage and elevation adjustment
- Pin Tumbler coil spring System design provides better shock absorbability and resistance
- Each direction adjust to 60 MOA
- RXR reticle has two functions: Quick Targeting Round X circle and range estimation
- Shockproof, waterproof and fogproof; 100% Argon filled and sealed with O-Ring
- Piano keyboard shape engraved grooves on all turrets and wheels' circumference makes it easy to adjust even when wearing gloves
- 44mm Objective Lens for ample light transmission
- Lifetime limited warranty (Electrical components covered one year).

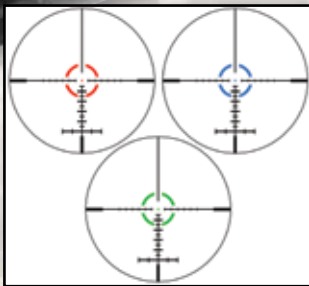

Presma® Hawk 6 Series Precision Rifle Scopes

Presma® Hawk 6 Series 1-6X28 Precision Scope, RGB RXR Glass Reticle

PRHA6011

- Clear and Sharp Image formation. Edge to edge image clarity
- Emerald coated lens, fully multi-coated, for the most excellent light transmission
- One piece 35 mm tube body with Cardan joint design constructed in premium aircraft class aluminum, hard anodized and matte finish for durability
- Red, Green, Blue tri-color reticle illumination button on unique 45 degree tube surface with last active color memory function. Automated power off to conserve battery's life
- Ocular Lens equipped with bubble level to align mounting scope and aiming level with unique 45 degree tube surface design that won't interfere with ocular lens viewing.
- QTA (Quick Tactical Adjustment) system applied in windage and elevation adjustment
- Pin Tumbler coil spring System design provides better shock absorbability and resistance
- Each direction adjust to 100 MOA

- RXR reticle has two functions: Quick Targeting Round X circle and range estimation
- Shockproof, waterproof and fogproof; 100% Argon filled and sealed with O-Ring
- Piano keyboard shape engraved grooves on all turrets and wheels' circumference makes it easy to adjust even when wearing gloves.
- Compact design
- Lifetime limited warranty (Electrical components covered one year).

PRESMA

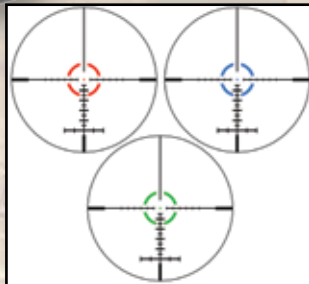

Patent Pending

Presma® Red / Green Dot Scopes

Presma® Red Hawk Series Compact Reflex Dot Scope

PRRH011

- 3.5 MOA dot diameter.
- 11 Levels of Green/ Red Dot density adjustment
- Density control is designated on easy and viewable 45 degree angle surface.
- Automatically returning to last dot density when power on.
- Access dot density adjustment button on the rear of Scope
- Emerald Multi-Coated Lens
- One-piece body CNC machined from 6061-T6 aluminum
- Low profile integrated picatinny ring mount
- Lightweight, Compact and Easy to Use Design
- O-ring sealed and Argon filled for waterproof, fogproof and shock proof performance.

Presma Red Hawk delivers a durable, lightweight, compact and easy to use design. Just Point and Shoot, it's that simple, fast and accurate.

Green and Red dot clickable button brightness controls is designed on 45 degree angle surface for quick access and easy to find.

Each color has 11 levels of density and automatically returns to last dot density when power is turned on.

The 3.5 MOA Red/Green dot diameter provides precise target of aim. The O-ring sealed and Argon filled one-piece body machined from 6061-T6 aluminum is waterproof, fogproof and shock proof performance. Low profile integrated picatinny ring mount offers quick mounting on AR's and shotguns.



Presma® Jackal Series Super Slim Free Float Handguards

Replacing the standard AR-15 handguard with a Presma® Jackal Series Mount free float quad rail enhances the tactical look for your firearm and provides an instant rock-solid platform for accessories.

Free float quad rails also offer other benefits too such as improved shooting accuracy. Since any pressure on the barrel by a grip or bipod will have an effect on shooting accuracy, which is amplified over longer distances, but our free float quad rail does not touch the barrel at all. No matter how much force you put on the bipod or grip, it will have zero effect on the barrel.



- Attaches directly to the upper receiver via a barrel nut (included)
- Fits: 223 / 5.56, AR15 / M14
- Lightweight Free Floating Barrel Design
- Full Length Uninterrupted Mil-Spec 1913 Picatinny rails on top
- Keymod accessory hole system on both sides and bottom
- Aircraft Grade Aluminum with Matte Fully finish and Anodized Hard Coat done in the USA
- Each Handguard includes 1 steel barrel nut and Teflon coated screws

PRJA041 - Presma® Jackal Series Super Slim Free Float Handguards, 15"
PRJA031 - Presma® Jackal Series Super Slim Free Float Handguards, 12"
PRJA021 - Presma® Jackal Series Super Slim Free Float Handguards, 10"
PRJA011 - Presma® Jackal Series Super Slim Free Float Handguards, 7"

Presma® Jackal Series Super Slim Free Float Handguards

New All-Around Keymod Accessory System

This Jackal Series Handguard features an optimized one-piece, free float structure. This design demonstrates the ergonomic and durability; that users demand while maintaining the lightweight nature they can expect from Presma.

The Jackal Handguard's lean and user-friendly design allows operators to maintain better control of the firearm. The top, uninterrupted and versatile picatinny rail provides the user an adequate amount of space for sights and accessories. This new rail also includes full all-around integrated Keymod holes for Multiple Keymod rail attachments.

Now available in 16.5 inch lengths.



- Attaches directly to the upper receiver via a barrel nut (included)
- Fits: 223 / 5.56, AR15 / M14
- Lightweight Free Floating Barrel Design
- Full Length Uninterrupted Mil-Spec 1913 Picatinny rails on top
- Keymod accessory hole system on all sides
- Aircraft Grade Aluminum with Matte Fully finish and Anodized Hard Coat done in the USA
- Each Handguard includes 1 steel barrel nut and Teflon coated screws

- PRJA091 - Presma® Jackal Series Super Slim Free Float Handguards, 16.5"
- PRJA081 - Presma® Jackal Series Super Slim Free Float Handguards, 15"
- PRJA071 - Presma® Jackal Series Super Slim Free Float Handguards, 12.5"
- PRJA061 - Presma® Jackal Series Super Slim Free Float Handguards, 10"
- PRJA051 - Presma® Jackal Series Super Slim Free Float Handguards, 7"

Presma® Kangaroo Series Slim Quad Rail Free Float Handguards

The Presma® Kangaroo Series Slim Full Length Quad Rail Design is optimized to give the best of both worlds...

Lightweight, yet strong and durable with the ability to add multiple Picatinny Accessories in a wide variety of applications. Our Full Length Mil-Spec 1913 Picatinny Quad Rail will meet your Durability and Tactical needs.



- Attaches directly to the upper receiver via a barrel nut (included)
- Fits: 223 / 5.56, AR15 / M14
- Lightweight Free Floating Barrel Design
- Full Length Mil-Spec 1913 Picatinny Quad Rails
- Aircraft Grade Aluminum with Matte Fully finish and Anodized Hard Coat done in the USA
- Each Handguard includes 1 steel barrel nut and Teflon coated screws

PRKA031 - Presma® Kangaroo Series Slim Free Float Handguards, 12"
PRKA021 - Presma® Kangaroo Series Slim Free Float Handguards, 10"
PRKA011 - Presma® Kangaroo Series Slim Free Float Handguards, 7"

Presma® Gorilla Series Super Slim .308 Free Float Handguards

The Presma® Gorilla Series is one of the strongest and slimmest AR10 .308 handguard options on the market. While also simultaneously boasting versatility equal to any of the heavier, bulkier full quad rail handguard designs.



- Attaches directly to the upper receiver via a barrel nut (included)
- Fits: .308 AR10
- Lightweight Free Floating Barrel Design
- Full Length Uninterrupted Mil-Spec 1913 Picatinny rails on top
- Keymod accessory hole system on both sides and bottom
- Aircraft Grade Aluminum with Matte Fully finish and Anodized Hard Coat done in the USA
- Each Handguard includes 1 steel barrel nut and Teflon coated screws

PRGO031 - Presma® Gorilla Series .308 Super Slim Free Float Handguards, 15"
PRGO021 - Presma® Gorilla Series .308 Super Slim Free Float Handguards, 12"
PRGO011 - Presma® Gorilla Series .308 Super Slim Free Float Handguards, 10"

The Presma® Gorilla Series handguards are now available with Full All-Around Keymod System and available in 16.5 in ch Lengths.



PRGO071 - Presma® Gorilla Series .308 Super Slim Keymod Free Float Handguards, 16.5"
PRGO061 - Presma® Gorilla Series .308 Super Slim Keymod Free Float Handguards, 15"
PRGO051 - Presma® Gorilla Series .308 Super Slim Keymod Free Float Handguards, 12.5"
PRGO041 - Presma® Gorilla Series .308 Super Slim Keymod Free Float Handguards, 10"

Presma® Wing Series Quick Release Scope Rings

Presma® Wing Series Scope Ring is made of aircraft grade aluminum Alloy. Machined precisely by CNC. Center lug machined to places. It will fit 1913 picatinny Mil spec rails and mounts. It has a quick release button attached to secure the rail, along with 4 screws to fasten upper and lower half of the scope ring firmly. The bottom of the ring has a see-through hole, designed to be used as a front sight if necessary.



Presma Wing Series, 1" Quick Release Button High Profile Scope Rings for Picatinny/ Weaver Rail; 4 screws for best results

PRWG010

- 1" Diameter
- High Profile See Through Rings;
- Picatinny/ Weaver Rail design
- Upper Half Ring Top features 2 slot rails.
- Matte Finish Hard Black Anodized
- Aircraft Grade Aluminum Alloy
- Precise CNC Machined
- Center lug machine into position
- 3mm Allan wrench includes extra screw
- 4 screws to fasten scope ring to ensure best security
- Quick Release Button, Attached securely to Picatinny Rail



Presma Wing Series, 1" Quick Release Button Medium Profile Scope Rings for Picatinny/ Weaver Rail; 4 screws for best results

PRWG020

- 1" Diameter
- Medium Profile See Through Rings
- Picatinny/ Weaver Rail design
- Matte Finish Hard Black Anodized
- Aircraft Grade Aluminum Alloy
- Precise CNC Machined
- Center lug machine into position
- 3mm Allan wrench includes extra screw
- 4 screws to fasten scope ring to ensure best security
- Quick Release Button, Attached securely to Picatinny Rail
- Upper Half Ring Top features 2 slot rails.



Presma® Wing Series Quick Release Scope Rings

Presma Wing Series, 30 mm Quick Release Button Medium Profile Scope Rings for Picatinny/ Weaver Rail; 4 screws for best results

PRWG030

- 30 mm Diameter
- Medium Profile See Through Rings
- Picatinny/ Weaver Rail design
- Matte Finish Hard Black Anodized
- Aircraft Grade Aluminum Alloy
- Precise CNC Machined
- Center lug machine into position
- 3mm Allan wrench includes extra screw
- 4 screws to fasten scope ring to ensure best security
- Quick Release Button, Attached securely to Picatinny Rail
- Upper Half Ring Top features 2 slot rails



Presma Wing Series, 30 mm Quick Release Button High Profile Scope Rings for Picatinny/ Weaver Rail; 4 screws for best results

PRWG040

- 30 mm Diameter
- High Profile See Through Rings
- Picatinny/ Weaver Rail design
- Matte Finish Hard Black Anodized
- Aircraft Grade Aluminum Alloy
- Precise CNC Machined
- Center lug machine into position
- 3mm Allan wrench includes extra screw
- 4 screws to fasten scope ring to ensure best security
- Quick Release Button, Attached securely to Picatinny Rail
- Upper Half Ring Top features 2 slot rails.



Presma Wing Series, 1" Quick Release Button Cantilever Integrated Scope Rings for Picatinny/ Weaver Rail; 4 screws for best results

PRWG050

- 1" Diameter
- Cantilever Integrated See Through Rings
- Picatinny/ Weaver Rail design
- Matte Finish Hard Black Anodized
- Aircraft Grade Aluminum Alloy
- Precise CNC Machined
- Center lug machine into position
- 3mm Allan wrench includes extra screw
- 6 screws to fasten scope ring to ensure best security
- Quick Release Button, Attached securely to Picatinny Rail



Presma Wing Series, 30 mm Quick Release Button Cantilever Integrated Scope Rings for Picatinny/ Weaver Rail; 4 screws for best results

PRWG060

- 30 mm Diameter
- Cantilever Integrated See Through Rings
- Picatinny/ Weaver Rail design
- Matte Finish Hard Black Anodized
- Aircraft Grade Aluminum Alloy
- Precise CNC Machined
- Center lug machine into position
- 3mm Allan wrench includes extra screw
- 6 screws to fasten scope ring to ensure best security
- Quick Release Button, Attached securely to Picatinny Rail



Presma® Owl Series Soft Touch Binoculars

The Presma™ Owl Series Binoculars are designed for adapting to the tough, water-proof and fog-proof conditions and environments like outdoor activities in bird watching, hiking, hunting, and nature observation. The Presma Binoculars are an ideal essential to carry around during your leisure activities, bringing the scene close to you. A tough protective rubber armor with a newly added diamond cut grip ensures a secure grip while protecting the binoculars from tough use.



Owl Series Binoculars 8X34 - 124m/1,000m

PROW011

- Nitrogen or Argon gas purging with O-ring seals.
- Phase-corrected prism for sharper image and contrast.
- Rubber armor for water-proofing and shock resistance.
- High Density.
- Fully multi-coated.
- Die electric multi layered.



Owl Series Binoculars 10X34 - 106m/1,000m

PROW021



Owl Series Binoculars 8X26 - 356ft/1,000yds

PROW031



Owl Series Binoculars 10X26 - 302ft/1,000yds

PROW041



Owl Series Binoculars 8X42 - 325ft/1,000yds

PROW051



Owl Series Binoculars 10X42 - 266ft/1,000yds

PROW061



Presma® Gun Cases

Presma® 47" Double Rifle Soft Case

GC01-B

- 47" Double Rifle Case is constructed of heavy duty PVC material, and protects up to 2 46" or short rifles.
- The dimensions, 47"x12"x3.5"(expansion included)
- The primary compartment will accommodate 2 rifles 47 inches in overall length with a thick padded center divider and 4 insert pocket and loop straps to properly secure each rifle.
- The secondary compartment 26"x 11" is loaded with pockets out side to store extras such as handguns, optics, cleaning supplies, log books, etc.
- The three exterior pockets are perfect for keeping your magazines and ammo organized.
- Extra PALS looping on each end allows you to customize your case for your specific needs.
- Two adjustable shoulder straps with an adjustable sternum strap allow you to carry the rifle case like a backpack.
- All pockets feature Heavy Duty zippers with pull cords for fast and easy access.
- Other features include wrap around carry handle straps and top and bottom compression straps.

This double rifle case is a great rifle case for any tactical or practical purpose.

This case allows you to carry two rifles with accessories such as scopes, sights, extended clips, fore grips and bipods with additional pockets to store your extra magazines and other equipment.

The Modular design of this case features a carry handle and back pack shoulder straps you can carry the load evenly across your back to keep your hands free. Lots of padding, pockets, and straps to secure your gear. Heavy double-zipper body features for locks to be applied for transport and the thick material ensures long lasting durability.



Sniper® Scopes

Long Distance 6-24 Magnification Hunting Rifle Scope with R/G/B/ Illuminated Mil Dot Reticle, Front AO Parallax Adjustments and 50mm Objective Lens

LT6-24X50AOL

- RGB tri-illumination mil-dot reticle
- Crystal clear multi-coated lens for excellent glare reflection and maximum light transmission
- Parallax adjustment/front AO feature allows for fine-tuning of target image
- Parallax adjustable from 15 yds to infinity - excellent for long range hunting and shooting
- Quick tactical zero locking/resetting target turrets for windage and elevation adjustment at 1/4 moa per click
- 6061 T6 aircraft grade body with strong Cardan Joint
- Ball and bearing windage/elevation adjustment
- Shockproof, waterproof, fogproof
- Attachable stackable 3" sunshade, High profile Picatinny scope rings, batteries and flip open lens caps included



Sniper® Scopes

Long Distance 4-16 Magnification Hunting Rifle Scope with R/G/B/ Illuminated Mil Dot Reticle, Front AO Parallax Adjustments and 40mm Objective Lens

LT4-16X40AOL

- RGB tri-illumination mil-dot reticle
- Crystal clear multi-coated lens for excellent glare reflection and maximum light transmission
- Parallax adjustment/front AO feature allows for fine-tuning of target image
- Parallax adjustable from 10 yds to infinity - excellent for long range hunting and shooting
- Quick tactical zero locking/resetting target turrets for windage and elevation adjustment at 1/4 moa per click
- 6061 T6 aircraft grade body with strong Cardan Joint
- Ball and bearing windage/elevation adjustment

- Shockproof, waterproof, fogproof
- Attachable stackable 2.5" sunshade, high profile Picatinny scope rings, batteries and flip open lens caps included
- Limited 1 year warranty - genuine Sniper scope



Long Distance 4-16 Magnification Hunting Rifle Scope with R/G/B/ Illuminated Mil Dot Reticle, Front AO Parallax Adjustments and 50mm Objective Lens

LT4-16X50AOL

- RGB tri-illumination mil-dot reticle
- Crystal clear multi-coated lens for excellent glare reflection and maximum light transmission
- Parallax adjustment/front AO feature allows for fine-tuning of target image
- Parallax adjustable from 10 yds to infinity - excellent for long range hunting and shooting
- Quick tactical zero locking/resetting target turrets for windage and elevation adjustment at 1/4 moa per click
- 6061 T6 aircraft grade body with strong Cardan Joint
- Ball and bearing windage/elevation adjustment

- Shockproof, waterproof, fogproof
- Attachable stackable 3" sunshade, high profile Picatinny scope rings, batteries and flip open lens caps included
- Limited 1 year warranty - genuine Sniper scope



Sniper® Scopes

3-12 Magnification CQB Tacticle Rifle Scope with R/G/B/ Illuminated Mil Dot Reticle and 40mm Objective Lens

LT3-12X40ML

- 1 piece 6061 T6 aircraft grade body with strong Cardan Joint and built-in integral angled sunshade
- Fully multi-coated lens for best light transmission with super clear image and brightness
- R/G/B illuminated mil-dot reticle for hold over/under precision aiming and enhanced aiming convenience on variant environment and low light condition
- User friendly QTA (Quick Tactical Adjustment) tactical turrets with precise 1/4 MOA click value for windage and elevation adjustment
- Includes mid-profile Picatinny rings & flip-open lens caps
- Completely sealed and Nitrogen filled to be shockproof, fogproof and rainproof

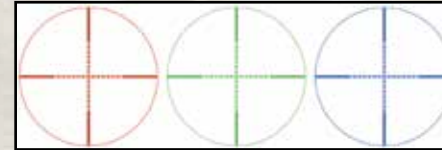

4X32M Compact Scope with Mil-dot Reticle

LT4X32M

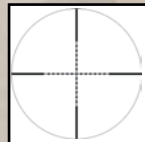

- 1 piece 6061 T6 aircraft grade aluminum body with strong Cardan Joint platform
- Mil-dot reticle
- Includes regular lens caps and Picatinny scope rings
- Completely sealed and Nitrogen filled to be shockproof, fogproof and rainproof

4X32MR Compact Scope with Rangefinder Reticle

LT4X32MR

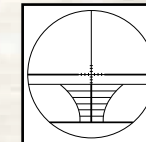

- 1 piece 6061 T6 aircraft grade aluminum body with strong Cardan Joint platform
- Rangefinder reticle
- Includes regular lens caps and Picatinny scope rings
- Completely sealed and Nitrogen filled to be shockproof, fogproof and rainproof

Sniper® Scopes

Compact Tactical 35mm RG Dot Scope With Mount

LTRD35

- 1 Piece 6061 T6 aircraft grade aluminum body with strong Cardan Joint and built-in integral angled sunshade
- Great field of view and unlimited eye relief
- Side wheel dual red/green dot
- Quick aim and instant lock on target
- Includes flip up lens caps and Picatinny scope ring mount



For more Quality Scopes and Red Dots, check out our Presma Section.

Product	Mag X	Length	Weight	1 Click	Obj. Dia.	Reticle Style	Exit Pupil	Field of View	Tube Dia.	W/E Adj. Value	Eye Relief	Parallax	Battery	Diopter range
LT6-24X50AOL	6-24X	16 inch	26.2 oz	1/4 MOA	50 mm	Mil-Dot	8.3-2.1 mm	15.2-3.8 Ft	1 inch	±25MOA	3.3-3.1 inch	15-infi	2032	-2D/+2D
LT4-16X40AOL	4-16X	14.4 inch	22.2 oz	1/4 MOA	40 mm	Mil-Dot	10-2.5 mm	24.8-6.2 Ft	1 inch	±25MOA	3.3-3.1 inch	10-infi	2032	-2.75D/+2D
LT4-16X50AOL	4-16X	15.2 inch	25.7 oz	1/4 MOA	50 mm	Mil-Dot	10-3.1 mm	22.4-5.6 Ft	1 inch	±25MOA	3.3-3.1 inch	10-infi	2032	-2D/+2D
LT3-12X40ML	3-12X	11.2 inch	16.2 oz	1/4 MOA	40 mm	Mil-Dot	12.8-3.5 mm	31.9-9.3 Ft	1 inch	±30MOA	3.5-3.4 inch	100 yds	2032	-2D/+2D
LT4X32M	4X	7.7 inch	8.5 oz	1/4 MOA	32 mm	Mil-Dot	8 mm	28 Ft	1 inch	±40MOA	3 inch	100 yds	N/A	-2.5D/+3D
LT4X32MR	4X	7.7 inch	8.5 oz	1/4 MOA	32 mm	Rangefinder	8 mm	28 Ft	1 inch	±40MOA	3 inch	100 yds	N/A	-2.5D/+3D

Product	Length	1 Click	Obj. Dia.	Reticle Style	Exit Pupil	Tube Dia.	W/E Adj. Value	Eye Relief	Parallax	Battery
LTRD35	7.6 inch	1/2 MOA	35 mm	Red/Green-Dot	22 mm	30mm	±40MOA	Infi	Infi	2032

Sniper® Handguards and Rail Mounts

AR15 2 Piece Drop In Handguard Quad Rail Mount, Carbine Length 6.7"

MQRSL

- Straight swap for factory carbine length handguard for .223 AR-15 variants
- Black Matte Finish. Two pieces. Machined in Aircraft Aluminum Alloy
- Easy install, no gunsmithing required - screws and hex tool included
- Length 6.7", Width 2.5", Height 2.2", Weight 11.5oz
- Fits Round Handguard End Cap (not included)



AR15 2 Piece Drop In Handguard Quad Rail Mount, Carbine Length 6.7" with Extended Top Rail

MQRSLX

- Features extended top rail to bridge gap over delta ring for .223 AR-15 variants
- Black Matte Finish. Two pieces. Machined in Aircraft Aluminum Alloy
- Easy install, no gunsmithing required - screws and hex tool included
- Length 6.7", Width 2.4", Height 2.24", Weight 11.8oz
- Fits Round Handguard End Cap (not included)



Our most popular quad rail. Easy to install - just remove your existing carbine length handguard and replace / 'drop-in' this one. No need to remove the front sight post or make any modifications.

Four rails of Picatinny accessory slots mean you can add a variety of tactical accessories such as foregrip, bipod, tactical flashlight and laser sight.



Mini Free Floating Forend Holding System for .223 / 5.56 AR15 - 4" length

MFFAR4



- Easy to install. 20 alignment holes on barrel nut for precise and secure fit
- Non slip holding surface - knurled finish
- Fits .223 - barrel nut and tools included
- Length 4", Weight 5.2oz

Carbine Length Free Floating Forend Holding System for .223 / 5.56 - AR15 - 7" length

MFFAR7

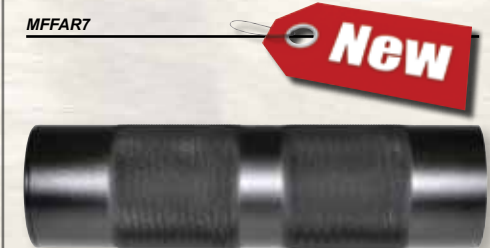

- Easy to install. 20 alignment holes on barrel nut for precise and secure fit
- Non slip holding surface - knurled finish
- Fits .223 - barrel nut and tools included
- Length 7", Weight 8.7oz

Sniper® Handguards and Rail Mounts

AR15 2 Piece Drop In Handguard Quad Rail Mount, Mid Length 8.7”

MQRML

- Great replacement for factory mid length handguard for .223 AR-15 variants
- Black Matte Finish. Two pieces. Machined in Aircraft Aluminum Alloy
- Easy install, no gunsmithing required - screws and hex tool included
- Length 8.75”, Width 2.5”, Height 2.25”, Weight 15.1oz
- Fits Triangle Handguard End Cap (not included)



AR15 2 Piece Drop In Handguard Quad Rail Mount, Mid Length 8.7”

MQRML-A

- Great replacement for factory mid length handguard for .223 AR-15 variants
- Black Matte Finish. Two pieces. Machined in Aircraft Aluminum Alloy
- Easy install, no gunsmithing required - screws and hex tool included
- Length 8.75”, Width 2.5”, Height 2.25”, Weight 15.1oz
- Fits Round Handguard End Cap (not included)



AR15 2 Piece Handguard Quad Rail Mount, Rifle Length 12”

MQRRL

- Straight swap for factory Rifle length handguard for .223 AR-15 variants
- Black Matte Finish. Two pieces. Machined in Aircraft Aluminum Alloy
- Easy install, no gunsmithing required - screws and hex tool included
- Length 12”, Width 2.5”, Height 2.25”, Weight 20.3oz
- Fits Triangle Handguard End Cap (not included)



AR15 2 Piece Handguard Quad Rail Mount, Rifle Length 12”

MQRRL-A

- Straight swap for factory Rifle length handguard for .223 AR-15 variants
- Black Matte Finish. Two pieces. Machined in Aircraft Aluminum Alloy
- Easy install, no gunsmithing required - screws and hex tool included
- Length 12”, Width 2.5”, Height 2.25”, Weight 20.3oz
- Fits Round Handguard End Cap (not included)



Sniper® Handguards and Rail Mounts

AK47/AK74 2 Piece Duct Cover Handguard Rail Mount

MTQRA

- Replaces duct cover and provides four sides of 14 Picatinny accessory mount slots
- Black Matte Finish
- Machined in Aircraft Aluminum Alloy
- Ready to install, all tools and screws included (no gunsmithing required)
- Length 8.5", Width 2.28", Height 3.27", Weight 17.1oz



Saiga 12 Shotgun 2 Piece Handguard Picatinny Quad Rail

MSG12

- Add Picatinny slots to all four sides of your Saiga 12 shotgun
- See-thru
- Black Matte Finish
- Machined in Aircraft Aluminum Alloy
- Length 15.8", Width 2.28", Height 3.11", Weight 17.1oz



AK47 Yugo 70 2 Piece Duct Cover Accessory Rail Mount

MTQRM



- 54 standard Picatinny accessory slots. 9 Top, 15 each Left/Right/Bottom
- Anodized Black Matte Finish
- Machined in Aircraft Aluminum Alloy
- Length 6.69", Width 2", Height 3", Weight 9.8oz

Saiga 39 (7.62x39) 2 Piece Handguard Quad Rail

MSG39



- Upgrade from the factory handguard to add Picatinny slots on all 4 sides
- Black Matte Finish
- Machined in Aircraft Aluminum Alloy
- Length 9.17", Width 2.44", Height 3.07", Weight 14.9oz

AK47/AK74 2 Piece Polymer OverMold Railed Handguard

MQAK



- Made of high quality polymer
- 2 pieces with Integrated rail: 11 top and 10 bottom Picatinny slots with single slot rail on both sides
- Length 6.38", Width 1.46", Height 1.81", Weight 4.4oz

AK47 Saiga 12/20/223/410 Quick Detachable Side Accessory Mount

MDSQA



- Black Powder Coated Aluminum
- Attaches directly to side mount plate (not included) and provides 12 top rail slots plus 8 side rail Picatinny slots
- Locks into place, easy install.
- Length 5.43", Width 3.27", Height 1.93", Weight 7.8oz

Sniper® Handguards and Rail Mounts

Ruger 10/22 Commando Tactical Quad Rail System

MMN14

- Excellent upgrade for Ruger 10/22 factory wood or synthetic plus any variants with the same dimensions as the factory stocks
- Simple and friendly installation, no gunsmith or tool required.
- Interlocking system features lower mount mating with upper mount
- Includes a special slot to accommodate rear iron sight specially.
- Designed groove rail top for optimal viewing through front sight.
- Four mil-spec picatinny rails: 33 top slots, 25 left and right side slots and 6 bottom slots.
- Length 15", Width 2.48", Height 2.36", Weight 11.8oz



Tactical .22 quad rail system. Great design and great fit on Ruger 10/22 rifle. Black rubber rail guards included.

Most affordable tactical solution. Attachable quick fit, easy install, no gunsmithing. A complete and most affordable tactical solution offering endless options of scope, flashlight, laser, bipod, foregrip on your favorite 10/22 rifles. Black rubber rail guards included.

Ruger Mini 14/Mini 30 Mil Spec Deluxe Side Mount with Top Rail

MM14

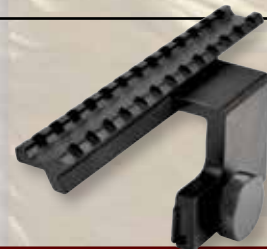

- Mounts directly to the side plate of the receiver and provides 14 Picatinny slots
- Easy install. Side plate locking point for easy installation, No gun smith needed
- Fits Mini 14 and Mini 30 only.
- Machined in Aircraft aluminum alloy
- Black Matte Finish
- Length 5.43", Width 1.8", Height 2.1", Weight 4.1oz

Ruger Mini 14 Mil Spec Deluxe Side Mount

M1M14



- 15 slot Picatinny top rail
- Side plate locking point for easy installation, No gun smith needed
- Works with existing iron sights
- One piece machined in Aircraft aluminum alloy
- Black Matte Finish
- Length 5.43", Width 1.85", Height 2.09", Weight 4.4oz

Ruger Mini 14/Mini 30 Handguard Quad Rail Mount

MMN1401



- Provides four sides of Picatinny slots
- Black matte finish
- Machined in Aircraft aluminum alloy
- Length 8.27", Width 2.72", Height 3.62", Weight 10.4oz

H&K MP5/MP522 Picatinny Tri Rail Accessory Mount Handguard

MBDPL



- Compatible with most Heckler & Koch MP5 Style firearms and variants (HK MP5, HK53, HK51 style rifles/pistols)
- Provides 36 Picatinny accessory slots. 12 each on L/R/Bottom rails
- Black matte finish
- One piece machined in Aircraft aluminum alloy
- Length 5.82", Width 2", Height 1.8", Weight 7.4oz

H&K MP5 G3 Claw Mount Dual Picatinny Rail Handguard Mount

MCLDR



- Ready for install and compatible with most MP5 and HK G3 style firearms
- Top and left Picatinny rails. 19 slots, 12 top & 7 left side).
- Black matte finish
- One piece machined in Aircraft aluminum alloy
- Length 5.2", Width 1.8", Height 1.8", Weight 6.1oz

Dovetail .22 to Picatinny Mount Rail Adapter

MAPRA



- Converts from your Dovetail 11mm-15mm rail to add 9 Picatinny slot rail
- Easy and quick install
- Secure fit
- Length 3.9", Width 1.02", Height 0.67", Weight 2.4oz

Sniper® Handguards and Rail Mounts

FN/FAL 2 piece Forend Handguard Quad Rail, AR Style

MHGQF

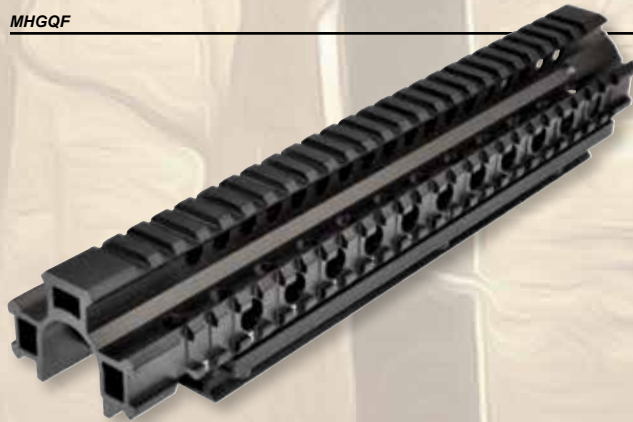

- Fits Both Metric and Inch Pattern FAL Rifles
- 97 Picatinny accessory slots: 25 on Top/Left/Right and 22 on bottom
- Stress Free Lockdown System
- Open Rear Design Allows Removal of Bolt & Carrier Assembly
- Black Matte Finish
- Machined in Aircraft Aluminum Alloy
- Length 11.5", Width 2.5", Height 4", Weight 22oz

FN/FAL Duct Cover Picatinny Rail Mount System

MTCRF



- Machined from Aircraft Aluminum Alloy
- Replaces factory dust cover and will fit these models: FN FAL LAR L1 A1 (R1A1 will require some minor filing)
- Large ejection port for optimum performance
- Low Profile Picatinny top rail with 21 Slots
- Integral sliding rail system
- Length 8.5", Width 1.73", Height 1.26", Weight 8.3oz

Remington 870 12 gauge Shotgun Low Profile Saddle Mount

MRM87



- Fits all Remington 870 models and variants
- 2 Locking bolts replace original trigger pins and mount straddles both sides of receiver.
- Low profile see-through feature and V-cut on top rail for use with iron sights
- No gunsmith or tool required
- Machined from Aircraft aluminum alloy
- 14 Picatinny Slots on Top Rail
- Length 7.1", Width 1.77", Height 2.55", Weight 5.3oz

Remington 870 Shotgun Lower Forend Handguard Tri Rail

M870B



- 27 Picatinny accessory slots, 7 L/R and 13 Bottom
- Grooved 'S' design for secure comfortable grip
- Machined from Aircraft aluminum alloy
- Length 7.37", Width 1.73", Height 1.78", Weight 11.9oz

H&K G36 Picatinny Rail Mount Set

MG36



- Set of 3 Picatinny rails designed for the G36 but with some slight modifications can be made to fit other guns. Will not work with G36C
- 3 rails - 7 slots R/L, 13 Base slots
- Machined Aircraft grade aluminum
- Base Rail Length 6", Side Rail Length 3.8"

Mossberg 500 Shotgun Base Picatinny Rail Mount

MSTRM



- Adds 13 Picatinny slots
- Machined Aircraft grade aluminum
- Thin/Slim profile
- Length 5.5", Width .82", Height .21", Weight 1.76oz

Mossberg Shotgun Top Rail Mount

MSTMF



- Picatinny/Weaver Style Shotgun Top Rail Mount to Fit Mossberg Shotguns
- 5.5" Long Picatinny Rail with 13 Slots.
- Complete with Mounting Screws Made of Aluminum
- Length 5.5", Weight 1.4oz

Sniper® Barrel Mounts

2 Piece Barrel Mount with Quad Rails - .51" - .78"

MBRQR



- Clamping Range Diameter .51-.78 - Fits wide range of firearms including standard AR15
- Attaches directly to barrel to provide additional 12 Picatinny rail slots. 3 each: top/left/right/bottom
- No gunsmithing required - ready to install
- Screws and tool provided
- Matte Black anodized Aircraft grade aluminum
- Length 1.9", Width 1.6", Height 1.5", Weight 2.8oz

3 Piece Low Profile Barrel Mount with Tri Rails - .51" - .78"

MBR05



- Clamping Range: Diameter .51"-.78"
- Attaches directly to barrel to provide additional 15 Picatinny rail slots. 5 each: top/left/right
- Clever 3 piece design for clamping rifle barrel and laser tube or even under barrel
- Matte Black anodized Aircraft grade aluminum
- Includes 3 sets of different length screws (short /medium/long) to ensure secure fit
- Length 2.36", Width 2.09", Height 1.54", Weight 4.8oz

3 Piece Low Profile Barrel Mount with Tri Rails - .51" - .78"

MBR02



- Clamping Range Diameter .51"-.78"
- Attaches directly to barrel to provide additional 6 Picatinny rail slots. 2 each: top/left/right
- Clever 3 piece design for clamping rifle barrel and laser tube or even under barrel
- Matte Black anodized Aircraft grade aluminum
- Includes 3 sets of different length screws (short /medium/long) to ensure secure fit
- Length 1.14", Width 2.09", Height 1.54", Weight 2.6oz

3 Piece High Profile Barrel Mount with Tri Rails

MBR5X



- Attaches directly to barrel to provide additional 15 Picatinny rail slots. 5 each: top/left/right
- Clever 3 piece design for clamping rifle barrel and laser tube or even under barrel
- Matte Black anodized Aircraft grade aluminum
- Includes 3 sets of different length screws (short /medium/long) to ensure secure fit
- Length 2.36", Width 2.36", Height 2.019", Weight 8.32oz

2 Piece Barrel Mount With Top Picatinny Rail

MBR5S



- Attaches directly to barrel to provide additional 5 Picatinny rail slots
- Matte Black anodized Aircraft grade aluminum
- Includes 3 sets of different length screws (short /medium/long) to ensure secure fit
- Length 2.36", Width 1.34", Height .95", Weight 2oz

12 Gauge Shotgun 15 Position Barrel Mount

MBRAR

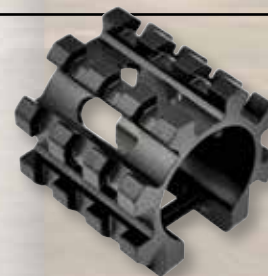

- Provides 5 different rail positions of with 3 Picatinny slots each - 15 in total
- Fits onto 12 gauge shotgun barrel
- Made from one piece for a secure accessory platform
- Matte Black anodized Aircraft grade aluminum
- Length 1.38", Width 1.5", Height 1.5", Weight 1.3oz

4/15 Tri Rail Barrel Mount for Front Sight Attachment

MBRTR



- Complete with 2 Sets of Barrel Adaptors for Standard Barrel, Bull Barrel or Light Weight Barrel
- Attaches to Model 4/15 Barrel and Compatible with A2 Front Sight and Bayonet Lug
- Made from Aircraft Aluminum with Black Anodizing
- Includes Left, Right and Bottom Picatinny Rails, Each with 6 Slots
- Easy Installation and Rock Solid Locking
- Length 2.6", Width 2", Height 3.3", Weight 3.3oz

Sniper® Riser Mounts



1" High Profile Riser Mount - 2 Picatinny Slots

MRSSH2

- See Thru
- Quick and easy install with thumb screw
- Matte Black anodized Aircraft grade aluminum
- Centre of ring to top of rail/base mount: 0.95"
- Length 1.22", Width 1.5", Height 1", Weight 1.4oz



1" High Profile Riser Mount - 3 Picatinny Slots

MRSSH3

- See Thru
- Quick and easy install with thumb screw
- Matte Black anodized Aircraft grade aluminum
- Centre of ring to top of rail/base mount: 0.95"
- Length 1.57", Width 1.5", Height 1", Weight 2.1oz

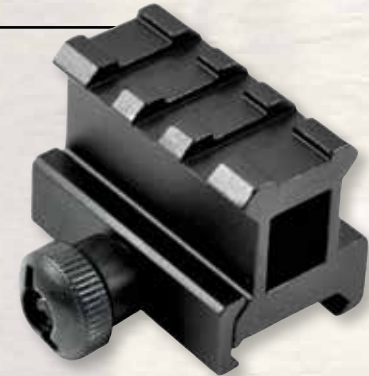

0.83" Medium Profile Riser Mount - 3 Picatinny Slots

MRSSM3



- See Thru
- Quick and easy install with thumb screw
- Matte Black anodized Aircraft grade aluminum
- Centre of ring to top of rail/base mount: 0.78"
- Length 1.61", Width 1.5", Height 0.83", Weight 1.2oz

0.83" Medium Profile Riser Mount - 7 Picatinny Slots

MRSSM7

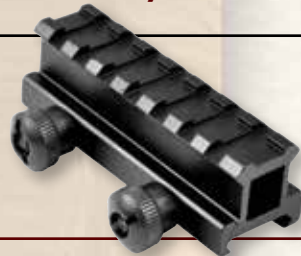

- See Thru
- Quick and easy install with thumb screw
- Matte Black anodized Aircraft grade aluminum
- Centre of ring to top of rail/base mount: 0.78"
- Length 3.1", Width 1.5", Height 0.83", Weight 3.2oz

0.5" Low Profile Riser Mount - 2 Picatinny Slots

MRSSL2



- See Thru
- Quick and easy install with thumb screw
- Matte Black anodized Aircraft grade aluminum
- Centre of ring to top of rail/base mount: 0.39"
- Length 1.22", Width 1.5", Height 0.5", Weight 1.4oz

0.5" Low Profile Riser Mount - 3 Picatinny Slots

MRSSL3



- See Thru
- Quick and easy install with thumb screw
- Matte Black anodized Aircraft grade aluminum
- Centre of ring to top of rail/base mount: 0.39"
- Length 1.61", Width 1.5", Height 0.5", Weight 1.8oz

1" High Profile Riser Mount - 14 Picatinny slots

MRSLLH



- See Thru with cut outs for sight posts
- Quick and easy install with thumb screw
- Matte Black anodized Aircraft grade aluminum
- Centre of ring to top of rail/base mount: 0.95"
- Length 5.71", Width 1.5", Height 1", Weight 5.9oz

0.83" Medium Profile Riser Mount - 13 Picatinny slots

MRSLLM



- See Thru with cut outs for sight posts
- Quick and easy install with thumb screw
- Matte Black anodized Aircraft grade aluminum
- Centre of ring to top of rail/base mount: 0.78"
- Length 5.71", Width 1.5", Height 0.83", Weight 5.4oz

0.5" Low Profile Riser Mount - 13 Picatinny slots

MRSLLL



- See Thru with cut outs for sight posts
- Quick and easy install with thumb screw
- Matte Black anodized Aircraft grade aluminum
- Centre of ring to top of rail/base mount: 0.39"
- Length 5.71", Width 1.5", Height 0.5", Weight 4.2oz

45 Degree Offset Picatinny 4 Slot Rail Mount

MOFAR



- Plate locking pin for secure fit
- Perfect for smaller accessories which don't need to be on the top rail
- Also good for offsetting back up iron sights
- Matte Black anodized Aircraft grade aluminum
- Length 1.77", Width 1.69", Height 0.43", Weight 1.2oz

Sniper® Grips

AR Style Grip, Black

GP20

- Premium grade Mil-Spec Reinforced Polymer Composite
- Built for lasting and rugged use
- Easy to grip comfort holding system, better Control by Extended Beaver-tail
- Storage for tools or batteries
- Height 4.5"



Tactical Vertical Short Foregrip

GP03

- Premium grade Mil-Spec Reinforced Polymer Composite
- Storage for tools or batteries
- Height 4"



AR Style Grip, Green

GP20-G

- Premium grade Mil-Spec Reinforced Polymer Composite
- Easy to grip comfort holding system, better Control by Extended Beaver-tail
- Storage for tools or batteries
- Height 4.5"



AR Style Grip, Tan

GP20-T

- Premium grade Mil-Spec Reinforced Polymer Composite
- Easy to grip comfort holding system, better Control by Extended Beaver-tail
- Storage for tools or batteries
- Height 4.5"



Tactical Slim 3 Position Folding Foregrip

GP05

- Black Polymer Composite Construction
- Easy to grip comfort holding system
- 3 Adjustable Positions
- Height: 4.5"



Tactical 5 Position Folding Foregrip

GP17

- Premium grade Mil-Spec Reinforced Polymer Composite
- 5 Adjustable Positions
- Storage for tools or batteries
- Height 4.75"



Tactical 5 Position Folding Foregrip, Black

GP02

- Black Polymer Construction
- 5 Adjustable Positions.
- Ergonomic Finger Grooves
- Clever End Cap Conceals Battery Storage and Controls
- Practical Side Slides Allow for Ambi-use of Pressure Pad
- Height: 5.5"



Tactical 5 Position Folding Foregrip, Green

GP02-G

- Green Polymer Construction
- 5 Adjustable Positions.
- Ergonomic Finger Grooves
- Clever End Cap Conceals Battery Storage and Controls
- Practical Side Slides Allow for Ambi-use of Pressure Pad
- Height: 5.5"



Tactical 5 Position Folding Foregrip, Tan

GP02-T

- Tan Polymer Construction
- 5 Adjustable Positions.
- Ergonomic Finger Grooves
- Clever End Cap Conceals Battery Storage and Controls
- Practical Side Slides Allow for Ambi-use of Pressure Pad
- Height: 5.5"



Tactical Folding Foregrip

GP08

- Military Spec Reinforced Black Polymer Composite
- Easy to Grip Comfort Holding System
- Storage Compartment with Plug.
- Can be used with our Bipod BP10



Sniper® Grips

Remington 870 Pistol Grip with Stock Adapter, AR style

GP21

- Allows any AR-15 stock to be mounted to your Remington 870 shotgun
- With 3 shell holder
- AG-43 pistol grip integrated 3 ammos holder
- Finger swells and extended beavertail
- Height 6", Weight 10oz



Mossberg 500 Shotgun Grip

GPM500

- Allows any AR-15 stock to be mounted to your Mossberg 500 shotgun
- Finger swells, extended beavertail, backstrap
- Hex screw, hex wrench, locking ring, washer included.



Tactical Foregrip With Storage Compartment, Black

GP04



- Military Spec Reinforced Black Polymer Composite with Matte Finish
- Grip Side Rail for Remote, Laser Control Panel Insertion
- Storage Compartment
- Height: 5.4", Weight: 5.6oz

Tactical Foregrip With Storage Compartment, Tan

GP04-T



- Military Spec Reinforced Tan Polymer Composite with Matte Finish
- Grip Side Rail for Remote, Laser Control Panel Insertion
- Storage Compartment
- Height: 5.4", Weight: 5.6oz

Flashlight and Laser Sight Grips can be found on page 45



Aluminum Tactical Foregrip With "O" Ring sealed Storage

GP16



- Constructed from Aircraft Grade Aluminum
- Comfort Grip Holding System
- Storage Compartment
- End cap with "O" ring for seal
- Height: 5"

AK47/74 Grip

GPAK



- Black Polymer
- Comfortable grip with textured handle.
- Height 4.41", Weight 3.7oz

Tactical Foregrip With Storage Compartment, Green

GP04-G



- Military Spec Reinforced Green Polymer Composite with Matte Finish
- Grip Side Rail for Remote, Laser Control Panel Insertion
- Storage Compartment
- Height: 5.4", Weight: 5.6oz

Sniper® AR15 BiPods

Tactical Precision Bipod with Foldable and Spring Loaded Legs

BP07

- Adapter for AR-15 Handguard Sling Stud, Picatinny Rail Sling Stud
- Strong and Lightweight Aluminum Construction
- Spring-loaded, Folding Legs with Rubberized Feet
- Posi-Lock Wheel on legs with Quick Retraction Button
- Height: 5.5" - 8", Weight: 11.1oz



Tactical Precision Bipod with Foldable and Spring Loaded Legs

BP08



- Adapter for AR-15 Handguard Sling Stud, Picatinny Rail Sling Stud
- Strong and Lightweight Aluminum Construction
- Spring-loaded, Folding Legs with Rubberized Feet
- Posi-Lock Wheel on legs with Quick Retraction Button
- Height: 7" - 11", Weight: 15oz

Tactical Low Profile Folding Bipod

BP01



- Aircraft Aluminum Construction
- Weaver/Picatinny Mounting Base
- Rubberized Comfort Stand
- Height: 4.9" (Center of Rail to Ground)
- Weight: 7.4oz

Tactical Folding Bipod with Extendable Legs

BP03



- High Tech Durable Aluminum Construction
- Can be Used in Clever Picatinny and Swivel Stud Mounting Systems
- Unique Posi-lock to Prevent Tipping and Rubberized Feet
- Panning with Fully Adjustable Center Height from 7" to 8.25", Weight: 8.2oz



Dragon Claw Clamp-on Bipod SWAT/Combat Profile

BP02

Dragon Claw Clamp-on Bipod with Height Adjustable Legs

BP04

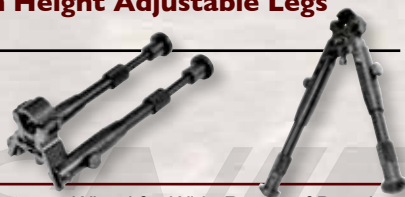

- Adjustment Wheel for Wide Range of Barrel Sizes from .43" to 0.75", Weight: 9.2oz
- Spring Operated Clamp-on Feature
- Adjustable Center Height 8.5" to 9.5"
- Panning Posi-lock Extendable Legs, Foldable Legs Swivel Stud/Picatinny Mount and Rubberized Feet
- Aluminum Construction

Dragon Claw Clamp-on Bipod with Height Adjustable Legs

BP06



- Adjustment Wheel for Wide Range of Barrel Sizes from .43" to 0.75", Weight: 10.2oz
- Spring Operated Clamp-on Feature
- Adjustable Center Height 9 to 11"
- Panning Posi-lock Extendable Legs, Foldable Legs, Swivel Stud/Picatinny Mount and Rubberized Feet
- Aluminum Construction

Modular Adjustable Picatinny/Weaver Precision Bipod Legs

BP09



- 2 Piece Detachable and Foldable Bipod Legs
- Heavy duty with Lightweight Aluminum Construction
- Rubberized feet
- Adjustable Height of 8"-10", Weight: 2.7oz ea



- Adjustment Wheel for Wide Range of Barrel Sizes from .43" to 0.75", Weight: 8oz
- Spring Operated Clamp-on Feature
- Tactical Low Profile Fixed Height
- High Tech Durable Aluminum Construction
- Unique Posi-lock to Prevent Tipping and Rubberized Feet

Sniper® Scope Rings

Medium Profile 1" Scope Rings for Dovetail System

AG-25M2



- 2 fasten screws per Ring
- Aircraft-grade aluminum alloy
- Anodized black matte finish
- 14mm Saddle Height up to 52mm outer bell.

Medium Profile 1" Scope Rings for Dovetail System

AG-25M4



- 4 fasten screws per Ring
- Aircraft-grade aluminum alloy
- Anodized black matte finish
- 14mm Saddle Height up to 52mm outer bell.

High Profile 1" Scope Rings for Dovetail System

AG-25H4



- 4 fasten screws per Ring
- Aircraft-grade aluminum alloy
- Anodized black matte finish

Medium Profile 30mm Scope Rings for Dovetail System

AG-30M4



- 4 fasten screws per Ring
- Aircraft-grade aluminum alloy
- Anodized black matte finish



High Profile 30mm Scope Rings for Dovetail System

AG-30H4



- 4 fasten screws per Ring
- Aircraft-grade aluminum alloy
- Anodized black matte finish
- 21mm Saddle Height up to 70mm outer bell.

Low Profile 1" Scope Rings for Picatinny System

PT-25L2



- 2 fasten screws per Ring
- Aircraft-grade aluminum alloy
- Anodized black matte finish
- See-thru Ring
- 10mm Saddle Height up to 45mm outer bell.

Medium Profile 1" Scope Rings for Picatinny System

PT-25M4



- 4 fasten screws per Ring
- Aircraft-grade aluminum alloy
- Anodized black matte finish
- See-thru Ring
- 14mm Saddle Height up to 53mm outer bell.

High Profile 1" Scope Rings for Picatinny System

PT-25H4



- 4 fasten screws per Ring
- Aircraft-grade aluminum alloy
- Anodized black matte finish
- See-thru Ring

Low Profile 30mm Scope Rings for Picatinny System

PT-30L4



- 4 fasten screws per Ring
- Aircraft-grade aluminum alloy
- Anodized black matte finish
- See-thru Ring
- 14mm Saddle Height up to 58mm outer bell.

Medium Profile 30mm Scope Rings for Picatinny System

PT-30M4



- 4 fasten screws per Ring
- Aircraft-grade aluminum alloy
- Anodized black matte finish
- See-thru Ring

High Profile 30mm Scope Rings for Picatinny System

PT-30H4



- 4 fasten screws per Ring
- Aircraft-grade aluminum alloy
- Anodized black matte finish
- See-thru Ring
- 22mm Saddle Height up to 72mm outer bell.

Check out our new
Presma Wing Series Scope
Rings, pages 23-24



Sniper® Scope Rings

1" Scope Ring Cantilever Integral Mount for Picatinny System

PT-25EX614

- 3 fasten screws per Ring
- Adds 8 more Picatinny Slots for mounting flashlights, laser sights and other accessories
- Aircraft-grade aluminum alloy
- Anodized black matte finish
- See-thru Ring
- Additional Picatinny Rails



30mm Scope Ring Cantilever Integral Mount for Picatinny System

PT-30EX614

- 3 fasten screws per Ring
- Adds 8 more Picatinny Slots for mounting flashlights, laser sights and other accessories
- Aircraft-grade aluminum alloy
- Anodized black matte finish
- See-thru Ring
- Additional Picatinny Rails

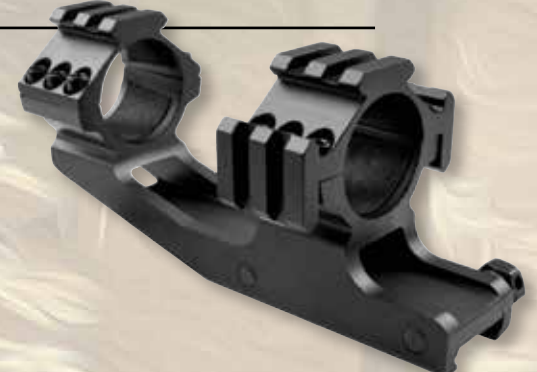

1" Scope Ring Cantilever Integral Mount for Picatinny System

PT-25EX210

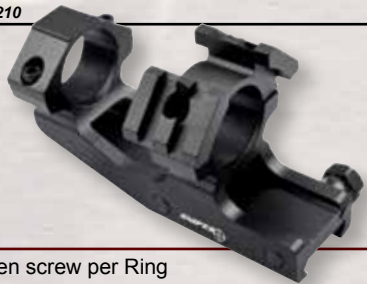

- 1 fasten screw per Ring
- Aircraft-grade aluminum alloy
- Anodized black matte finish
- See-thru Ring and adds 4 Picatinny Slots

1" Scope Ring Cantilever Integral Mount for Dovetail System

AG-25EX38

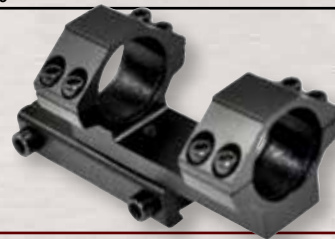

- 2 fasten screws per Ring
- Aircraft-grade aluminum alloy
- Anodized black matte finish

30mm Scope Ring Cantilever Integral Mount for Picatinny System

PT-30EX43

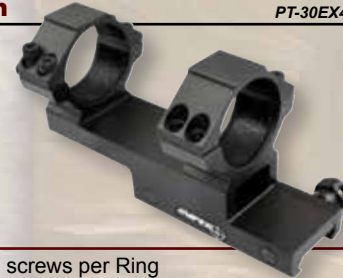

- 2 fasten screws per Ring
- Aircraft-grade aluminum alloy
- Anodized black matte finish
- See-thru Ring

35mm Scope Ring Cantilever Integral Mount for Picatinny System

PT-35EX614



- 3 fasten screws per Ring
- Aircraft-grade aluminum alloy
- Anodized black matte finish
- See-thru Ring

30mm Dia Cantilever Scope Ring Mount for Picatinny Systems

PT-30OF02



- Aircraft-grade aluminum alloy
- Anodized black matte finish
- See-thru Ring
- 1-1/4" Height

1" Scope Ring with Side Offset

PT-25OF01



- Aircraft-grade aluminum alloy
- Anodized black matte finish

Cantilever Scope Ring

MLC30



- Aircraft-grade aluminum alloy
- Designed for flat top AR
- Lifetime warranty
- Cantilever scope Ring

30mm Dia Scope Body Adapter with Picatinny Rail

MBRSR



- Aircraft-grade aluminum alloy
- Anodized black matte finish
- Fits onto 30mm scope body
- Adds additional 5 Picatinny slots

Sniper® Iron Sights

AR15 Standard Size Carry Handle with Flat Top Mount Area and Rear Sight

MCH15

- A2-style rear sight with precise windage/elevation adjustment
- Black
- Precision Machined Aluminum
- No Gunsmithing Required
- Quick and Easy Installation



Picatinny Rail for AR15 Carry Handle Top aMount

MCHTM



- See-thru under rail so doesn't interfere with view of iron sights
- Adds 12 Picatinny slots
- Easy thumb screw attachment
- Length: 5.18"

Rapid Transition AR-15 Flip Up Sight Set, 45 Degree Offset

MAFRS

- Black
- Machined from Lightweight, Extremely Durable 7075 Grade Aluminum
- Military Spec Hard Anodized
- 1/2 MOA Elevation and Windage Adjustment
- Mounting Base Length Front: 0.95". Rear: 0.95"
- Width Front: 2.11". Rear: 2.14"mm
- Weight 3.8oz

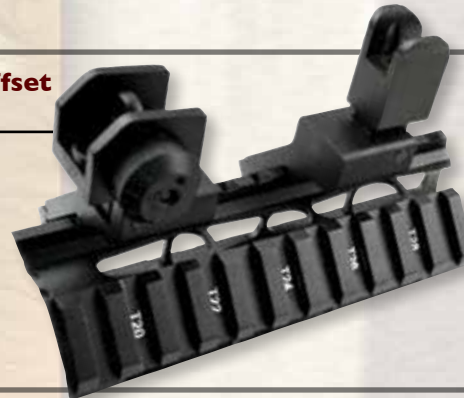

Sights with additional laser sight can be found on page 45

Tactical Flip Up Front Sights

MFLFS01 - High Profile

MFLFS02 - Low Profile



- Black
- Precision Machined Aluminum
- Complete with A2 Square Post Assembly with Locking Retention
- Thumb Nuts with Locking Retention for Maintaining Zero

Tactical Flip Up High Profile Rear Sight with Dual Aiming Aperture

MFLRS01



- Black
- Precision Machined Aluminum
- Precision Windage and Elevation Adjustments
- Thumb Nuts with Locking Retention for Maintaining Zero

Front Iron Sights

MDTFS01 - High Profile

MDTFS02 - Low Profile



- Black
- Complete with Adjustable A2 Square Post Assembly
- Precision Elevation Adjustments
- MDTFS01 Mounting Base Length 1.38", Saddle Height 1.66", Weight 2.7oz.

Complete Rear Sight

MDTRS02



- Black Matte
- Rugged Aluminum/Steel Construction
- Precision Mil Spec MOA Windage and Elevation Adjustments
- Spring Loaded Detent
- Dual Aiming Apertures
- Length: 2.8inch. Width: 1.8inch. Height: 1.9inch.

Sniper® Flip Up, Push Down Polymer Sights

Tactical Smart Polymer Front And Rear Flip Up, Push Down Sight Set

MFLRS02

- Black Polymer
- Complete with A2 Square Post Assembly, Locking Retention
- Precision Windage and Elevation Adjustments
- Clever and Robust Flip-up Posi-lock Design to Guarantee Zero
- Dual Aiming Apertures
- Lightweight and Durable
- 1" Height



Tactical Smart Polymer Front And Rear Flip Up, Push Down Sight Set

MFLRS04 - Set

- Black Polymer
- Front sight comes with Complete with A2 Square Post Assembly with Locking Retention
- Precision Windage and Elevation Adjustments
- Clever and Robust Flip-up Posi-lock Design to Guarantee Zero
- Dual Aiming Apertures
- Lightweight and Durable
- 1" Height

MFLRS05 - Rear only



Tactical Smart Polymer Front And Rear Flip Up Sight Set

MFLRS02-G



- Green Polymer
- Complete with A2 Square Post Assembly with Locking Retention
- Precision Windage and Elevation Adjustments
- Clever and Robust Flip-up Posi-lock Design to Guarantee Zero
- Dual Aiming Apertures
- Lightweight and Durable, 1" Height

Tactical Smart Polymer Front And Rear Flip Up Sight Set

MFLRS02-T



- Tan Polymer
- Complete with A2 Square Post Assembly with Locking Retention
- Precision Windage and Elevation Adjustments
- Clever and Robust Flip-up Posi-lock Design to Guarantee Zero
- Dual Aiming Apertures
- Lightweight and Durable, 1" Height

Tactical Smart Polymer Front Flip Up Sight

MFLFS03



- Black Polymer
- Complete with A2 Square Post Assembly with Locking Retention
- Precision Elevation Adjustments
- Clever and Robust Flip-up Posi-lock Design to Guarantee Zero
- Lightweight and Durable, 1" Height

Tactical Smart Polymer Front Flip Up Sight

MFLFS03-G



- Green Polymer
- Complete with A2 Square Post Assembly with Locking Retention
- Precision Elevation Adjustments
- Clever and Robust Flip-up Posi-lock Design to Guarantee Zero
- Lightweight and Durable, 1" Height

Tactical Smart Polymer Front Flip Up Sight

MFLFS03-T



- Tan Polymer
- Complete with A2 Square Post Assembly with Locking Retention
- Precision Elevation Adjustments
- Clever and Robust Flip-up Posi-lock Design to Guarantee Zero
- Lightweight and Durable, 1" Height

Tactical Smart Polymer Rear Flip Up Sight

MFLRS03



- Black Polymer
- Precision Windage and Elevation Adjustments
- Clever and Robust Flip-up Posi-lock Design to Guarantee Zero
- Dual Aiming Apertures
- Lightweight and Durable, 1" Height

Tactical Smart Polymer Rear Flip Up Sight

MFLRS03-G



- Green Polymer
- Precision Windage and Elevation Adjustments
- Clever and Robust Flip-up Posi-lock Design to Guarantee Zero
- Dual Aiming Apertures
- Lightweight and Durable, 1" Height

Tactical Smart Polymer Rear Flip Up Sight

MFLRS03-T



- Tan Polymer
- Precision Windage and Elevation Adjustments
- Clever and Robust Flip-up Posi-lock Design to Guarantee Zero
- Dual Aiming Apertures
- Lightweight and Durable, 1" Height

Sniper® Laser Sights and Flashlights

Compact Tactical Adjustable Red Laser Sight

LSR01

- Less Than 5mw
- Compact (2.2"Lx.56"W)
- Lightweight (less than 1 ounce including batteries)
- Constructed of High Quality Aircraft Grade Aluminum
- Pressure Switch and Batteries Included



High Profile Removable Front Sight and Red Laser Combo

MHFSR

- Combat Quality
- Complete with A2 Square Post Assembly
- Double Coil Springs for Precise Windage and Elevation Adjustment
- Laser Built on Cardan Joint Platform/Smart Spherical Structure
- Pressure Switch and Batteries Included

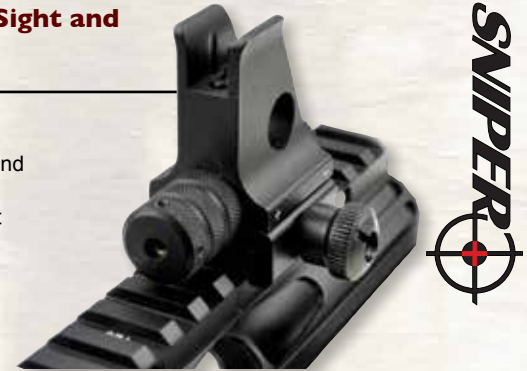

Low Profile Removable Front Sight and Red Laser Combo

MLFSR

- Combat Quality
- Complete with A2 Square Post Assembly
- Double Coil Springs for Precise Windage and Elevation Adjustment
- Laser Built on Cardan Joint Platform/Smart Spherical Structure
- Pressure Switch and Batteries Included



Tactical Flashlight with Rail Mount

FL02

- CREE LED bulb Q5. Ultra-high 260 lumen output
- Combat tactical front head
- Pushbutton momentary switch and twist-on permanent switch
- Intelligent high/low/strobe mode cycling



Tactical LED Flashlight and Red Laser Sight Combo

FLRL02

- Compact 200 lumens Cree LED Flashlight
- 3 Modes of Operation: Flashlight, Laser, Flashlight + Laser
- Laser Power Lower than 5mw
- Mounts directly to Picatinny rails
- Intelligent high/low/strobe mode cycling



Aluminum Fore Grip with Integral Flashlight

GPFL01

- 260 Lumens Flashlight with Cree Q5 LED
- Knurled Surface Holding System for Non-Slip Grip
- With O Ring sealed, waterproof
- Intelligent high/low/strobe mode cycling
- Height 5-1/2"



Aluminum Fore Grip with Flashlight and Red Laser Sight

GPRL01

- 260 lumens Flashlight with Cree Q5 LED
- Red Laser Less than 5mw
- Knurled Surface Holding System for Non-Slip Grip
- With O Ring sealed, waterproof
- Intelligent high/low/strobe mode cycling
- Height 5-1/2"



Aluminum Fore Grip with Flashlight and Green Laser Sight

GPGL01

- 260 lumens Flashlight with Cree Q5 LED
- Green Laser Less than 5mw
- Works in temperatures down to 14F
- Knurled Surface Holding System for Non-Slip Grip
- With O Ring sealed, waterproof
- Intelligent high/low/strobe mode cycling
- Height 5-1/2"



Sniper® Snap-on Fiber Optic Front Sight Kit for 12 / 20 Gauge Shotguns

MBFRS - Red

MBFGS - Green

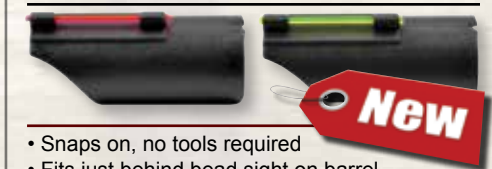

- Snaps on, no tools required
- Fits just behind bead sight on barrel.
- Excellent addition to any 12 or 20 gauge shotgun
- Easy to see in daylight and low light conditions
- Improves your shooting
- Does not work with ventilated barrels
- Measures: 0.7" x 0.87" x 2.1", Weights: 0.2oz



Sniper® Bore Laser Sights

.223 Red Laser Bore Sight

BSRL223

- Red Laser boresighter for .223
- Precise machined
- Batteries included



30/30 Winchester Red Laser Bore Sight

BSRL3030

- Red Laser boresighter for 30/30 Winchester
- Precise machined
- Batteries included



.223 and Archery Red Laser Bore Sight

BSL223



- Red Laser boresighter for .223 with threaded end for attaching to arrow shaft for Archery
- Precise machined
- Batteries included

.224/308 7mm-08 Red Laser Bore Sight

BSRL243



- Red Laser boresighter for .224/308/7mm-08
- Precise machined
- Batteries included

7mm Remington Mag Red Laser Bore Sight

BSRL7



- Red Laser boresighter for 7mm Rem Mag
- Precise machined
- Batteries included

7.62x39mm Red Laser Bore Sight

BSRL76239



- Red Laser boresighter for 7.62X39mm
- Precise machined
- Batteries included

7.62x54Rmm Red Laser Bore Sight

BSRL76254



- Red Laser boresighter for 7.62x54 R
- Precise machined
- Batteries included

8mm Red Laser Bore Sight

BSRL8



- Red Laser boresighter for 8mm
- Precise machined
- Batteries included

9mm Red Laser Bore Sight

BSRL9



- Red Laser boresighter for 9mm
- Precise machined
- Batteries included

12 Gauge Shotgun Red Laser Bore Sight

BSRL12GA



- Red Laser boresighter for 12 Gauge Shotguns
- Precise machined
- Batteries included

Sniper® Accessories

AR-15 6 Position Aluminum Buffer Tube Kit, Comm Spec

AS5P01

- Precision Machined from Premium Aircraft Grade Aluminum
- Matte Black Anodizing with Type III Class II Hard Coat
- Tightest Tolerance Control for Zero-Gap
- Kit includes 3oz Aluminum Buffer, 6 Position Buffer Tube, Castle Nut, Spring and End Plate.

AR-15 6 Position Aluminum Buffer Tube Kit, Mil Spec

AS5P02

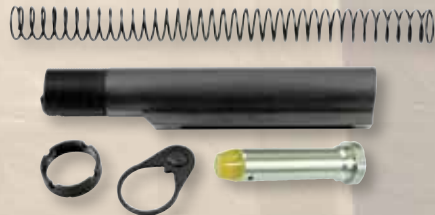

- Precision Machined from Premium Aircraft Grade Aluminum
- Matte Black Anodizing with Type III Class II Hard Coat
- Tightest Tolerance Control for Zero-Gap
- Kit includes 3oz Aluminum Buffer, 6 Position Buffer Tube, Castle Nut, Spring and End Plate

AR-15 6 Position Buffer Tube, Comm Spec

ASBT01



- Black
- Anodized Aircraft Aluminum Construction
- 7 1/8" Length
- 6 position adjustable

A2 Buffer Tube Assembly Kit for A2 or .308

AS5P04

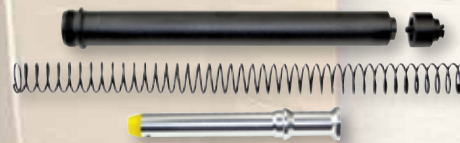

- A2 Buffer Tube Assembly kit is for mounting a M16A2 fixed buttstock
- Includes receiver extension tube, recoil buffer, buffer spring, buttstock spacer, & buttstock screw.

AR-15 6 Position Buffer Tube, Mil Spec

ASBT04



- Black
- Anodized Aircraft Aluminum Construction
- 7 1/8" Length
- 6 position adjustable

AR-15 Stock Buffer, Mil Spec

ASBF02



- Precision Machined from Premium Aircraft Grade Aluminum
- 3.0oz

A2 Buffer for A2 or .308

ASBF06



- A2 Buffer for M16A2 fixed buttstock

AR-15 Buffer Tube with Foam Wrap, Comm Spec

ASBT05



- Black
- Anodized Aircraft Aluminum Construction
- Foam Included
- 7.7" Length
- Helps slow the rearward portion of the bolt-cycle & ensure complete closing of the firing action

AR Tuned Buffer Spring

ABTS01

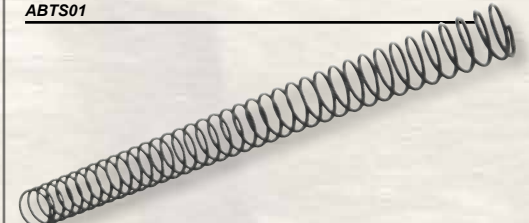

- Made from quality steel
- Strong and Durable
- Length: 10.7", Diam: 7/8", Weight: 1.7 oz

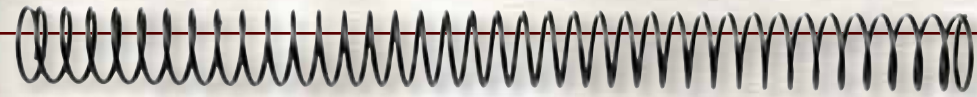

Sniper® Accessories

AR .223/5.56/.308 Buffer Tube Receiver End Plate

ABTA01

- High Quality Steel Construction



AR .223/5.56/.308 Buffer Tube Receiver End Plate

ABTA02



- High Quality Steel Construction

AR .223/5.56/.308 Buffer Tube Receiver End Plate

ABTA03



- High Quality Steel Construction

Heavy Duty Push Button QD Sling Swivel

AQDSL01



- Precision Machined from Premium Aircraft Grade Aluminum
- Matte Black Anodizing with Type III Class II Hard Coat
- 1.25"

Push Button Sling Swivel for Picatinny Rail

AQDSL05



- Aluminum alloy and steel
- Easy to attach anywhere on Picatinny rail system or handguard
- Very sturdy with a quick detach button

AR-15/ M16 Receiver Extension Castle Nut, Comm Spec

ABNT01



- Precision machined from Chrome Steel.

AR-15/ M16 Receiver Extension Castle Nut, Mil Spec

ABNT02



- Precision machined from Chrome Steel.

AR .223/5.56/.308 Buffer Tube Receiver End Plate

ABTA04



- High duty steel construction to meet hard environment, durable use
- Model 15, 223/556/308
- Major tactic experience, Mil Spec type
- Height: 2.05 IN; Width: 1.34 IN; Length: 0.19 IN; Weight: 0.7 OZ

AR .223/5.56/.308 Buffer Tube Receiver End Plate

ABTA05



- Carbon Steel Construction

Sniper® Accessories

Advanced Carbine Complete Comm Spec Butt-Stock

AAST02

AAST02-T, Tan

- Black
- Reduces metal on metal contact
- Constructed from Premium Quality Polymer
- With Sling Swivel
- Can Adapt to Either Rifle or Carbine Length Tubes



Advanced Carbine Complete Mil Spec Butt-Stock

AAST07



- Black
- Reduces metal on metal contact
- Constructed from Premium Quality Polymer
- With Sling Swivel
- Can Adapt to Either Rifle or Carbine Length Tubes

Advanced Carbine Complete Mil Spec Butt-Stock

AAST07-G



- Green
- Reduces metal on metal contact
- Constructed from Premium Quality Polymer
- With Sling Swivel
- Can Adapt to Either Rifle or Carbine Length Tubes

Buttstock Protective Cap

APCA01



- Black
- Durable Rubber Construction
- Tight Fit
- Fits our Sniper Buttstock AAST02, AAST07 and T6 or M4 style collapsible stocks

Buttstock Protective Cap

APCA02



- Black
- Durable Rubber Construction
- Tight Fit
- Fits Magpul MOE series and CRT series stocks

Advanced Carbine Complete Comm Spec Butt-Stock

AAST12-B, Black

AAST12-T, Tan

- Black or Tan
- Reduces metal on metal contact
- Constructed from Premium Quality Polymer
- With Sling Swivel
- Can Adapt to Either Rifle or Carbine Length Tubes



SNIPER®

Butt-Stock Shoulder Plates

AAST10

- Made of Zinc alloy
- Electrophoresis paint
- Fits AR buffer tube
- Only for rifles or short barrel rifles

AAST11

- Made of Zinc alloy
- Electrophoresis paint
- Fits A2 or .308 Buffer tube



These work perfect with our Butt-Stock Protective Caps (APCA02)

Sniper® Accessories

Protective Caps for Picatinny/Weaver Rails, Set of 12 Caps

MARC1

- Modular small size individual protective caps can be mounted in multiple places and in multiple configurations.
- Economical
- Reusable
- Easy to Release

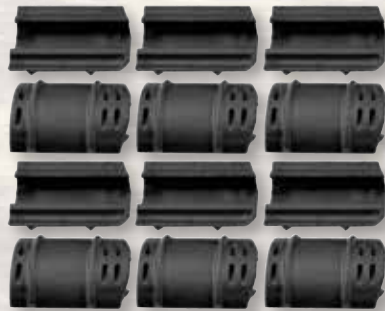

Protective Cover Strips for Keymod Rails, Set of 5 Strips

ASURC-B - Black

ASURC-G - Green

ASURC-T - Tan

- Low profile and lightweight
- Mount to KeyMod and most other industry standard, negative space, mounting systems
- Made of extremely heat resistant material
- Designed to combat sweat, grime, and grease to improve rifle contact points



A1 & A2 Front Iron Sight Post Adjustment Tool - 4 & 5 Prongs

FSTL01



- .223 Rifle Wrench
- Works on both A1 & A2 front sight posts - tool has 4 and 5 prongs
- Premium Steel Construction
- Anodized Black Matte

AR-15 Stock Combo Wrench Tool

ARTL02



- Steel construction
- 19.5cm x 5cm x 0.3cm 4 oz.

AR-15 Stock Combo Wrench Tool

ARTL03



- Steel construction
- 16cm x 4cm x 0.3cm 3.2 oz

AR Stock Handguard Splitter/Removal Tool

ARTL05



- All steel construction and hook is coated in a soft, pliable Plastic
- Non-slip rubber Finish.
- 15 x 4.2 x 2 inches ; 9.6 ounces

AR Delta Ring Suppressor Tool

ARTL06



- Construction: Steel Bar stock with Plastic Dip coating
- 10.6 x 2 x 2.6 inches
- 7 ounces

Reversible Lower Receiver Magazine Well Vice Block Tool

LVB



- For working on AR-15's
- Scratchproof, Solvent Resistant Polymer

AR-15 Low Profile Gas Block with Pin and Picatinny Rails, 0.75"

MLQGB



- Fits AR-15 0.75" Diam. Barrels
- 3 See-thru Picatinny Rails with 4 slots
- Black Matte Finish
- Machined in Aircraft Aluminum

Low Profile Gas Block

GB03



- Includes roll pin, screws & hex wrench
- Made from high quality steel.
- 1.45" x 0.98" x 1.03"
- 2.1 ounces
- Fits: .223 AR15

AR-15 Low Profile Gas Block, 0.75"

GB750



- Fits AR-15 0.75" Diam. Barrels
- Includes roll pin, screws & hex wrench

AR-10 Low Profile Gas Block, 0.936"

GB936



- Fits AR-10 0.936" Diam. Barrels
- Includes roll pin, screws & hex wrench

UVB



- Easy to use
- Constructed of Black Injection Molded Polymer.
- Fits Both Carry & Flattop Uppers.
- Length 3.4 in, Width 2.6 in, Height 4.6 in Weight 13.9 OZ

Sniper® Accessories

Cross Draw Tactical Multi Function Vest

ASVT02-T

- Made from strong 600X600 Polyester
- Zipped Wear for quick release
- Multiple pockets and attachments
- Heavy duty back loop system to carry additional gear/tools
- Fully adjustable in girth and length
- Durable rescue pull, mesh system helps release moisture and heat
- High quality zippers
- 4 deluxe adjustable rifle mag pouches
- 2 large internal zippered map/document pouches
- 3 bullet clip mag pouch



Tactical Belt

TBMP-B - Black

TBMP-G - Green

- High Quality Adjustable Quick Release Buckle System
- 2 Quick Release Pistol Magazine Pouches Included
- New Detachable Belt Keepers for Easy and Firm Grip to Regular Belt for Convenient Adjustment with Reinforced Threading and Double-edge Stitching
- Sturdy Hook-and-loop Adjustment of the Belt fits 30" to 52" Waist, Width 2" in
- Suitable for law enforcement and military use.
- Highly durable and versatile tactical CQB rigger belt
- 600D Nylon Cordura



Cross Draw Tactical Multi Function Vest

ASVT01-OD



Cross Draw Tactical Multi Function Vest

ASVT01-T



Cross Draw Tactical Multi Function Vest

ASVT01-B



Cross Draw Tactical Multi Function Vest

ASVT01-TC



Cross Draw Tactical Multi Function Vest

ASVT01-ACU



- Made from strong 600X600 Polyester
- Zipped Wear for quick release
- Multiple pockets and attachments
- Heavy duty back loop system to carry additional gear/tools
- Fully adjustable in girth and length

- Durable rescue pull, mesh system helps release moisture and heat
- High quality zippers
- 4 deluxe adjustable rifle mag pouches
- 2 large internal zippered map/document pouches
- 3 bullet clip mag pouch

Presma® Hawk and Hawk 6 Series Precision Rifle Scopes



Optics that match with markets premium brands scope's performance... Clear and Sharp Image formation with all round coverage edge to edge image clarity.

Hawk 6 Series - 1-6X28

Hawk Series - 6-24X50



Red, Green, Blue tri-color illumination button on unique 45 degree tube surface so it won't interfere with ocular lens viewing. Easy to adjust and comes with last active color memory function.

Ocular Lens equipped with bubble level to help align scope mounting and aiming level. During the course of shooting, it confirms rifle is always in horizon level.

Pin Tumbler coil spring system design provides better shock absorbability and resistant. During shooting recoil, the reticle stays in place, making the Hawk durable and keeps the aim accurate.

Table of Contents

Presma® Brand Products

Binoculars	pg 25
Gun Cases	pg 26
Handguard Mounts.....	pgs 19-22
Red Dots	pg 18
Scopes.....	pgs 2-17
Scope Rings.....	pgs 23-24

Sniper® Brand Products

Accessories	pgs 47-51
BiPods	pgs 39-40
Buffer Parts	pgs 47-48
Buttstocks	pg 49
Fore Grips	pgs 38-39
Handguard Mounts.....	pgs 31-35
Laser Sights	pgs 45-46
Red Dots	pg 30
Riser Mounts.....	pg 37
Scopes.....	pgs 27-29
Scope Rings.....	pgs 41-42
Sights.....	pgs 43-46

